

Chapter 20 Temperature Measurement of FB-PLC and PID Control

FB-PLC provides two kinds of modules with different outlook and size for temperature measurement. One kind of the modules is called slim module with 2 points of general purpose analog input & 4 points of temperature input, named by FB-2AJ4 (for J-type thermocouple), FB-2AK4 (for K-type thermocouple), FB-2AH4 (for PT-100) and FB-2AT4 (for PT-1000). They can be expanded up to 8 modules, with 32 temperature inputs in total at the most. The other kind has a built-in 4 points analog input module with large number of temperature measuring points, named by FB-4AJxx or FB4Akxx (the xx could provide 12, 18, and 24 totally 3 kinds of measuring points). This module with large number of points can only be used alone and can not be installed together with other temperature measuring module or with other analog input modules.

Both of the above-mentioned temperatures measuring modules have their properly convenient instructions that are used for multiplexing temperature measurement. FB-2AJ(K)4/FB-2AH(T)4 employs FUN72(TP4) while FB-4AJ(K)xx employs FUN85(TPSNS) to get the engineering value of temperature measurement. As to the temperature control, it also has its properly convenient PID instructions. FB-2AJ(K)4/FB-2AH(T)4 employs FUN73(TSTC) while FB-4AJ(K)xx employs FUN86(TPCTL) to perform the PID operation to control the heating or cooling of the temperature process.

20.1 Specifications of temperature measuring modules of FB-PLC

20.1.1 FB-2AJ(K)4 : with 4 points of J(K) thermocouple input and 2 points of analog input

Specifications			Module				
			FB-2AJ4		FB-2AK4		
Items							
Analog Input	Input points		2 (1 st & 2 nd analog inputs as the general purpose input) + 1 (3 rd analog input for temperature measurement)				
	Resolution		12 bits				
	Span	*Bipolar	*10V	1.Voltage	-10V ~ 10V	5.Current	-20mA~20mA
			5V	2.Voltage	-5V ~ 5V	6.Current	-10mA~10mA
		Unipolar	10V	3.Voltage	0V ~ 10V	7.Current	0mA~20mA
5V			4.Voltage	0V ~ 5V	8.Current	0mA~10mA	
Temperature Input	Input points		4 (Multiplexing via 3 rd analog input)				
	Expansion allowed		32 points (8 modules)				
	Sensor		J-type thermocouple		K-type thermocouple		
	Valid range	*Bipolar	*10V	-200°C~750°C		-200°C~900°C	
			5V	-200°C~420°C		-200°C~450°C	
		Unipolar	10V	0°C~750°C		0°C~900°C	
			5V	0°C~420°C		0°C~450°C	
	Resolution		1°C				
	Compensation		Built-in cold junction compensation				
	Update rate		2 Sec. (Adjustable)				
Accuracy		Within ±1% of full scale					
Insulation		Photocouple isolation					
Power supply		24VDC±10% · 5VA					

* : It means default setting.

20.1.2 FB-4AJ(K)12/18/24: with 12/18/24 points of J(K) thermocouple input and 4 points of analog input

Specifications			Module					
			FB-4AJ(K)12		FB-4AJ(K)18		FB-4AJ(K)24	
Analog Input	Input points		4 (1 st ~4 th analog inputs as the general purpose input) + 4 (5 th ~8 th analog inputs for temperature measurement)					
	Span	*Bipolar	*10V	1.Voltage	-10V ~ 10V	5.Current	-20mA~20mA	
			5V	2.Voltage	-5V ~ 5V	6.Current	-10mA~10mA	
		Unipolar	10V	3.Voltage	0V ~ 10V	7.Current	0mA~20mA	
			5V	4.Voltage	0V ~ 5V	8.Current	0mA~10mA	
Temperature Input	Input points (Fixed)		12		18		24	
	Sensor		J-type thermocouple (K-type thermocouple)					
	Valid range	*Bipolar	*10V	-200°C~750°C		(-200°C~900°C)		
			5V	-200°C~420°C		(-200°C~450°C)		
		Unipolar	10V	0°C~750°C		(0°C~900°C)		
			5V	0°C~420°C		(0°C~450°C)		
	Resolution		1°C					
	Compensation		Built-in cold junction compensation					
Update rate		2 Sec. (Adjustable)						
Accuracy		Within ±1% of full scale						
Insulation		Photocouple isolation						
Power supply		24VDC±10% · 5VA						

* : It means default setting.

20.1.3 FB-2AH(T)4: with 4 points of 3-wires PT-100 (PT-1000) RTD input and 2 points of analog input

Specifications			Module				
			FB-2AH4 (PT-100)		FB-2AT4 (PT-1000)		
Analog Input	Input points		2 (1 st & 2 nd analog inputs as the general purpose input) + 1 (3 rd analog input for temperature measurement)				
	Resolution		12 bits				
	Span (Bipolar)	*10V	*1.Voltage	-10V ~ 10V	3.Current	-20mA~20mA	
5V		2.Voltage	-5V ~ 5V	4.Current	-10mA~10mA		
Temperature Input	Input points		4 (Multiplexing via 3 rd analog input)				
	Expansion allowed		32 points (8 modules)				
	(Bipolar) Valid range	DIN	*10V	-49.8°C ~ 146.6°C			
			5V	-12.3°C ~ 83.6°C			
		JIS	*10V	-50.7°C ~ 149.2°C			
			5V	-12.5°C ~ 85.1°C			
Resolution		0.1°C					
Update rate		2 Sec. (Adjustable)					
Accuracy		Within ±1% of full scale					
Insulation		Photocouple isolation					
Power supply		24VDC±10% · 5VA					

* : It means default setting.

Note: The temperature modules mentioned above all with built-in general purpose analog inputs and dedicated analog input for temperature measurement, the memory mapping of these modules as followings:

Addressing of FB-2AJ(K)4 and FB-2AH(T)4 : The 1st and 2nd analog inputs are the general purpose input by accessing R3840 and R3841; and the 3rd analog input is dedicated for 4 points of temperature measurement (by multiplexing method) by accessing R3842 (if this module is the 1st analog input expansion module).

Addressing of FB-4AJ(K)xx : This kind of modules could only be installed alone, therefore, the 1st ~4th analog inputs are the general purpose input by accessing R3840 ~R3843, and 5th ~8th analog inputs are dedicated for upto 24 points of temperature measurement (by multiplexing method, one analog input for 6 points of temperature measurement).

20.2 The procedure of using temperature measuring module of FB-PLC Explanation

20.2.1 Temperature measurement only

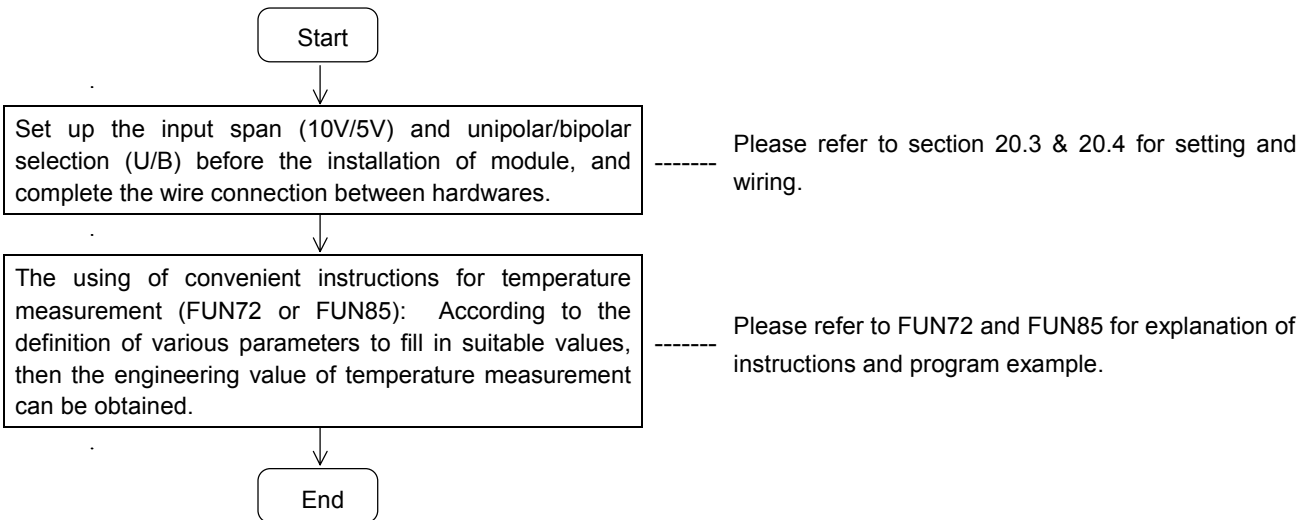

20.2.2 Closed loop PID temperature control

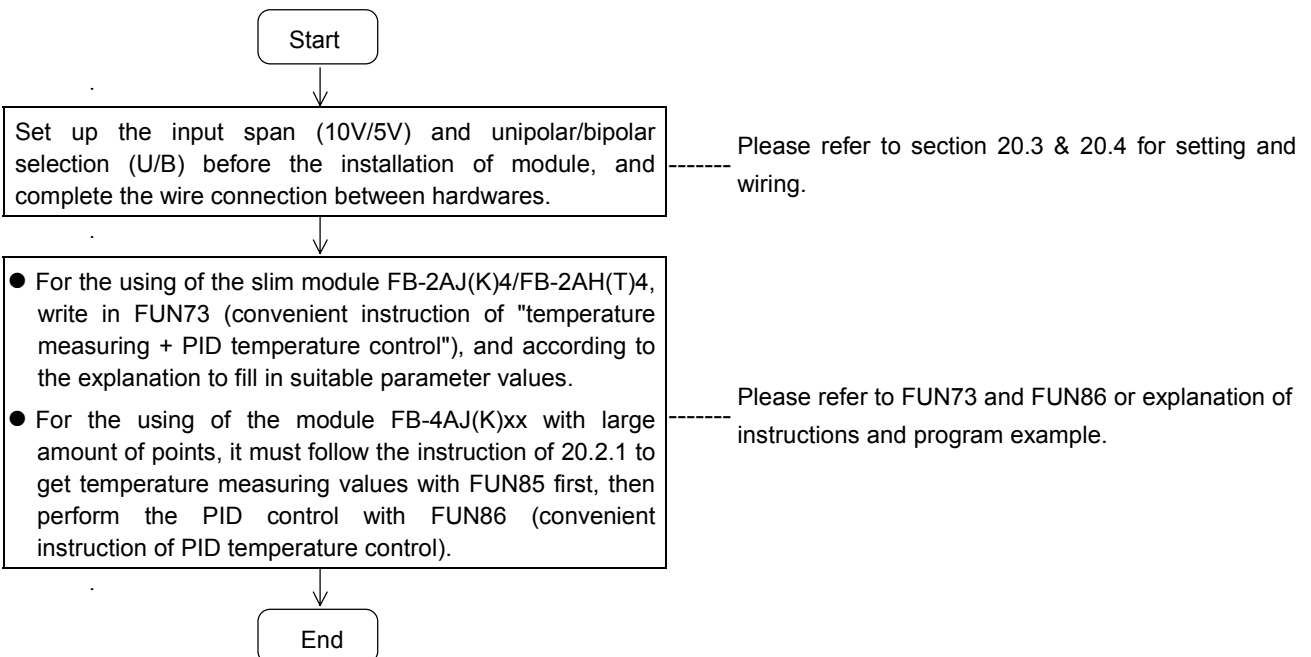

20.3 Explanation on the hardware of temperature measuring module

20.3.1 The outlook of FB-2AJ(K)4 and top view of PC-board

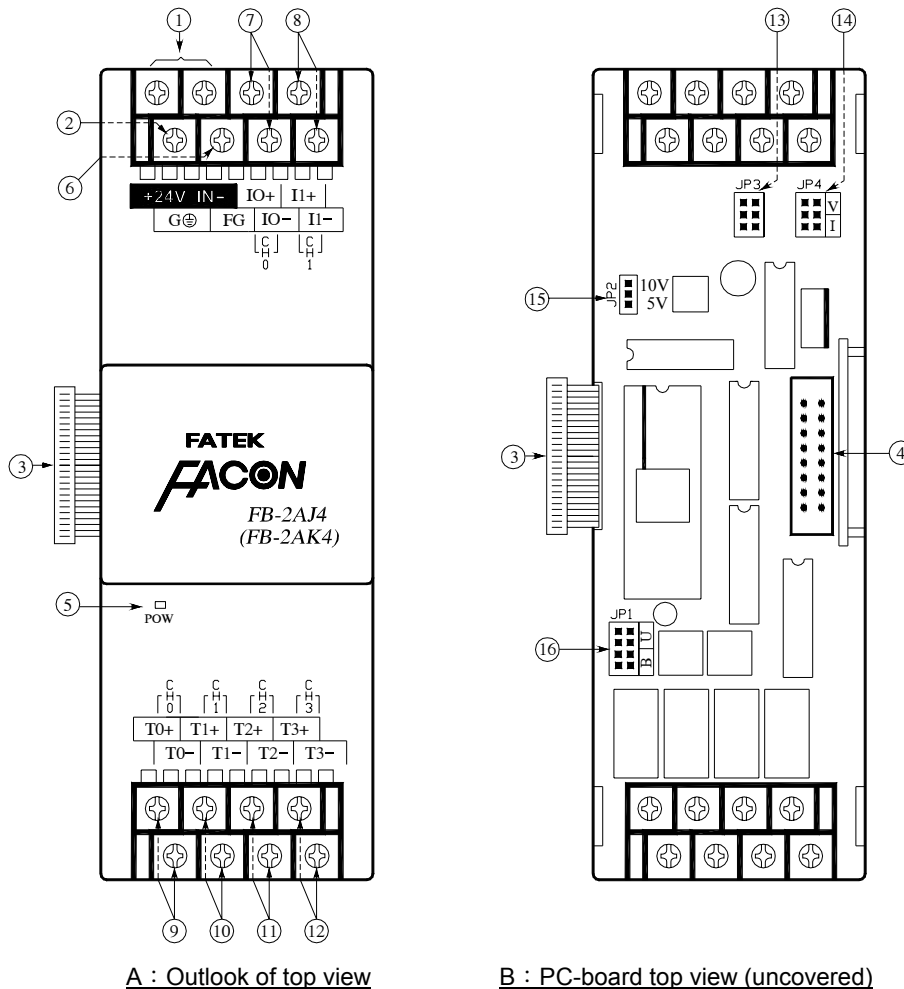

A : Outlook of top view

B : PC-board top view (uncovered)

- ① : External power input terminal –
Power supply for analogue circuit of FB-2AJ(K)4 module, supply voltage is 24VDC±20% ◦
- ② : Protection ground terminal –
To connect to the safety earth ground of the power system.
- ③ : Expansion input cable –
It must be connected to the front of expansion unit or main unit.
- ④ : Expansion output connector –
Provide the connection for next expansion unit.
- ⑤ : Power indicator –
Indicating the status of external power input and power supply of FB-2AJ(K)4 analogue circuit.
- ⑥ : Framing ground terminal –
To connect to the shielding of the analog input wiring.
- ⑦ : Analog input terminal for AI0 –
To connect to the 1st general purpose analog input.
- ⑧ : Analog input terminal for AI1 –
To connect to the 2nd general purpose analog input.

- ⑨ ~ ⑫ : Temperature input terminals for CH0 ~ CH3 – To connect to the corresponding thermocouple.

- ⑬ ◦ ⑭ Selection jumpers of voltage(V)/current(I) input for AI0 (JP3) and AI1 (JP4)

⑮ : Selection jumper of input span 10V/5V

The selection to define the input span of all analog inputs of this module. If setting the jumper at 10V position, it represents the measurement range of 10V/20mA/1000°C; if setting the jumper at 5V position, it represents the measurement range of 5V/10mA/500°C.

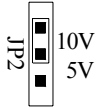
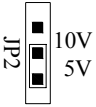
Jumper Setting				
Span of analog Input	Unipolar (U)	Voltage (V)	0V~10V	0V~5V
		Current (I)	0mA~20mA	0mA~10mA
	Bipolar (B)	Voltage (V)	-10V~10V	-5V~5V
		Current (I)	-20mA~20mA	-10mA~10mA
Span of Temperature input	Unipolar (U)	0°C~1000°C	0°C~500°C	
	Bipolar (B)	-1000°C~1000°C	-500°C~500°C	

⑯ : Unipolar (U)/Bipolar (B) selection

The selection to define the input polarity of all analog inputs of this module. These two jumpers must be inserted horizontally in pairs according to the U, B text direction (which is horizontally printed in its direction) to position B or U as following illustration.

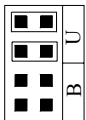
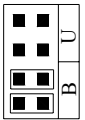
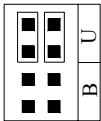
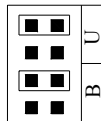
○		✕	
Unipolar (U)	Bipolar (B)	JP1	JP1
			
JP1	JP1	Jumper vertically inserted or not inserted in pairs are all incorrect	

20.3.2 The outlook of FB-4AJ(K)xx and top view of PC Board

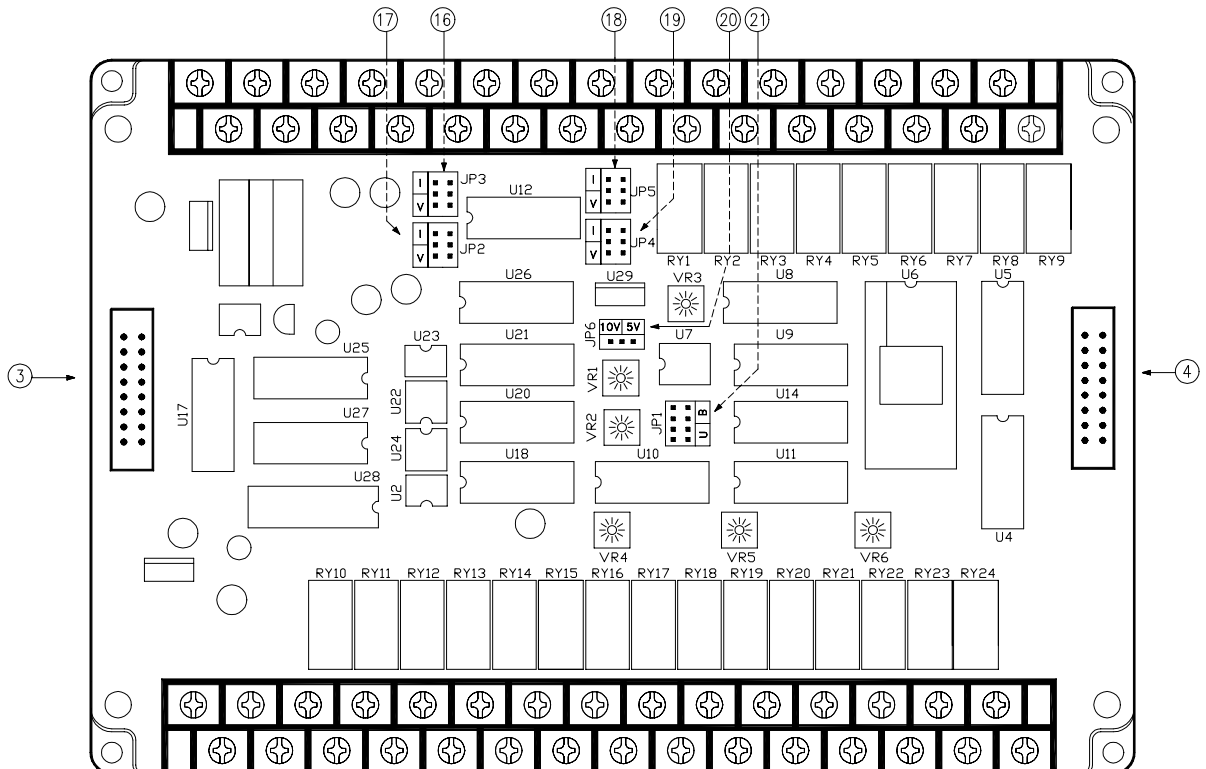
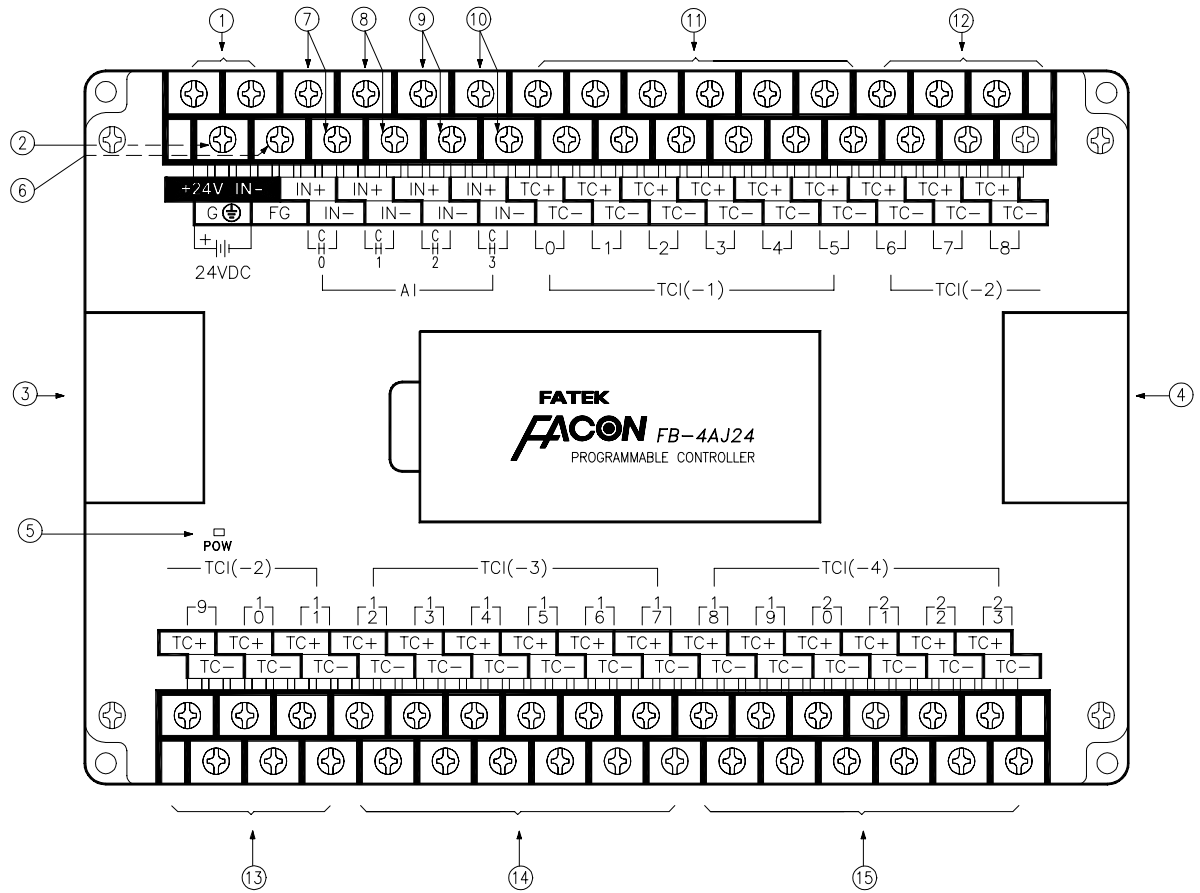

- ① : External power input terminal –
Power supply for analogue circuit of FB-4AJ(K)xx module, supply voltage is 24VDC±20% ◦
 - ② : Protection ground terminal –
To connect to the safety earth ground of the power system.
 - ③ : Expansion input cable –
It must be connected to the front of the expansion unit or main unit.
 - ④ : Expansion output connector –
Provide the connection of next expansion unit.
 - ⑤ : Power indicator –
Indicating the status of the external power input and the power supply for analogue circuit of this module.
 - ⑥ : Framing ground terminal –
To connect to the shielding of analog input wiring.
 - ⑦ : 1st analog input terminal (CH0) –
 - ⑧ : 2nd analog input terminal (CH1) –
 - ⑨ : 3rd analog input terminal (CH2) –
 - ⑩ : 4th analog input terminal (CH3) –
- This kind of module can be used alone and can't be installed together with other analog input module; therefore it has these 4 points of analog input at the most.
- ⑪ : 1st group of thermocouple input terminals (TC0~TC5) – To connect to corresponding thermocouple
 - ⑫~⑬ : 2nd group of thermocouple input terminals (TC6~TC11) – To connect to corresponding thermocouple
 - ⑭ : 3rd group of thermocouple input terminals (TC12~TC17) – To connect to corresponding thermocouple
(only for FB-4AJ(K)18 or FB-4AJ(K)24)
 - ⑮ : 4th group of thermocouple input terminals (TC18~TC23) – To connect to corresponding thermocouple
(only for FB-4AJ(K)24)
 - ⑯~⑲ : Selection jumpers for voltage(V)/current (I) input of analog inputs CH0~CH3
- The four analog inputs of FB-4AJ(K)xx can be selected individually to be voltage or current input (JP2 for CH0、JP3 for CH1、JP4 for CH2、JP5 for CH3). The selection and insertion of jumper must be identical in direction to the printed text V and I next to it and should be vertically inserted into the position of V or I in pairs.

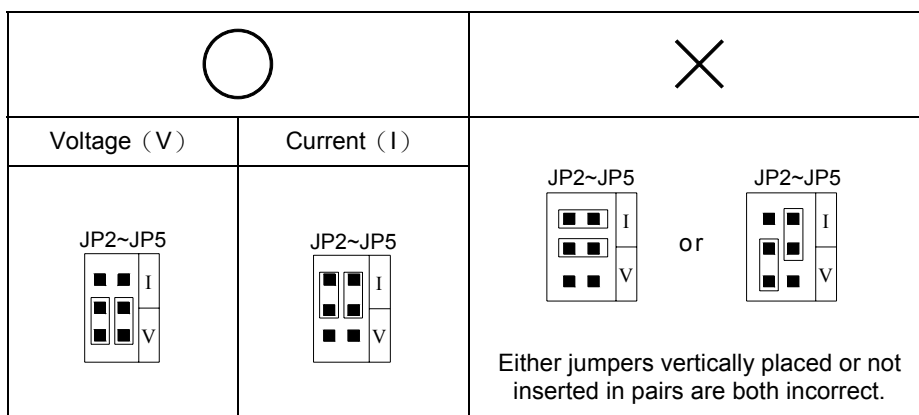

⑳ : Selection jumper of input span 10V/5V

The selection to define the input span of all analog inputs of this module. If setting the jumper at 10V position, it represents the measurement range of 10V/20mA/1000°C; if setting the jumper at 5V position, it represents the measurement range of 5V/10mA/500°C.

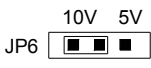
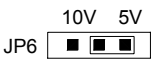
Jumper setting				
Analog input	Unipolar (U)	Voltage (V)	0V~10V	0V~5V
		Current (I)	0mA~20mA	0mA~10mA
	Bipolar (B)	Voltage (V)	-10V~10V	-5V~5V
		Current (I)	-20mA~20mA	-10mA~10mA
Temperature span	Unipolar (U)			0°C~500°C
	Bipolar (B)			-500°C~500°C

㉑ : Unipolar (U)/Bipolar (B) selection

The selection to define the input polarity of all analog inputs of this module. These two jumpers must be horizontally placed in pairs to position B or U, according to the marked text direction of B and U beside the jumper.

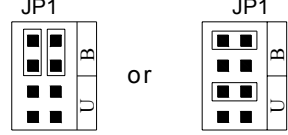
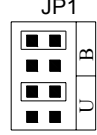
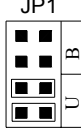
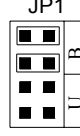
○		×
Unipolar (U)	Bipolar (B)	 or  Either jumpers vertically placed or not inserted in pairs are both incorrect.
		

20.3.3 The outlook of FB-2AH(T)4 and top view of PC-board

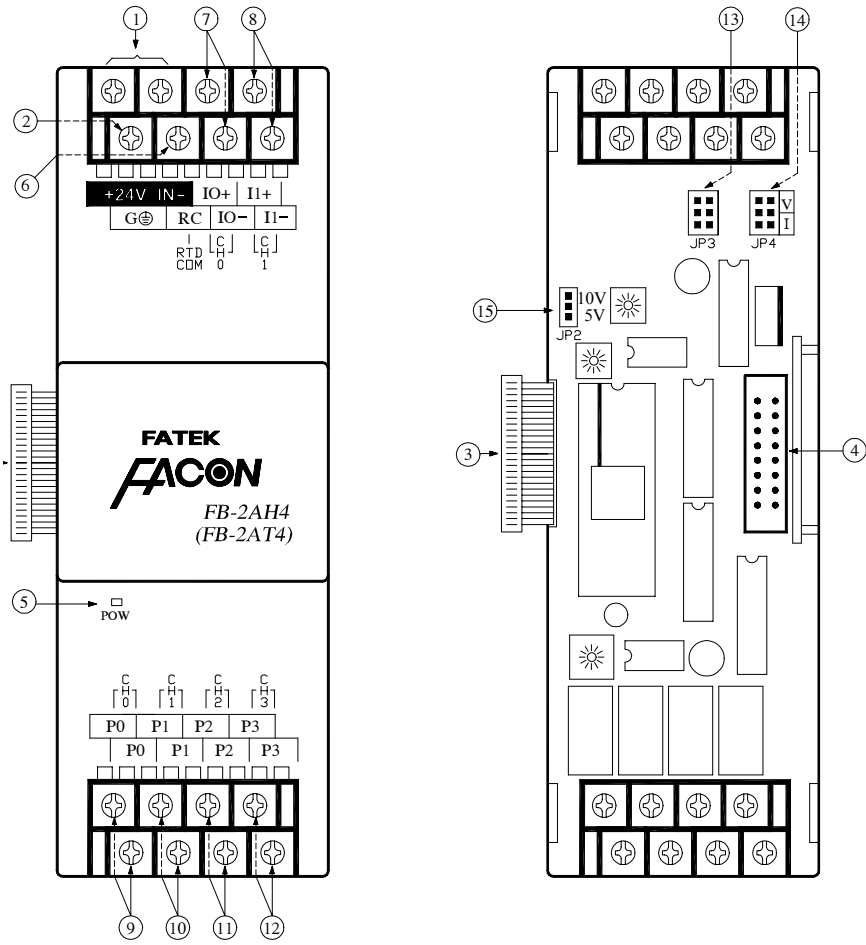

A : Outlook of top view

B : PC-board top view (uncovered)

- ① : External power input terminal –
Power supply for analogue circuit of FB-2AH(T)4 module, supply voltage is 24VDC±20% ◦
- ② : Protection ground terminal –
To connect to the safety earth ground of the power system.
- ③ : Expansion input cable –
It must be connected to the front of expansion unit or main unit.
- ④ : Expansion output connector –
Provide the connection for next expansion unit.
- ⑤ : Power indicator –
Indicating the status of external power input and power supply of FB-2AH(T)4 analogue circuit.
- ⑥ : Common terminal for 3-wires RTD input –
To connect to the common wire (in general ,the color is red) of each 3-wires RTD input.
- ⑦ : Analog input terminal for AI0 –
To connect to the 1st general purpose analog input.
- ⑧ : Analog input terminal for AI1 –
To connect to the 2nd general purpose analog input.
- ⑨ : Input terminal for 1st RTD input –
To connect to the signal wires (in general, the color is white) of 1st 3-wires RTD input.
- ⑩ : Input terminal for 2nd RTD input –
To connect to the signal wires (in general, the color is white) of 2nd 3-wires RTD input

⑪ : Input terminal for 3rd RTD input –

To connect to the signal wires (in general, the color is white) of 3rd 3-wires RTD input.

⑫ : Input terminal for 4th RTD input –

To connect to the signal wires (in general, the color is white) of 4th 3-wires RTD input.

⑬ · ⑭ Selection jumpers of voltage(V)/current(I) input for AI0 (JP3) and AI1 (JP4)

The jumper must be inserted vertically in pairs according to the V, I text direction (which is vertically printed in its direction) to position V or I as following illustration.

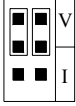
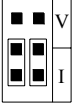
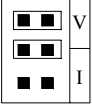
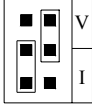
○		×	
Voltage (V)	Current (I)	JP3、JP4	JP3、JP4
			
<p>Either jumpers horizontally placed or not inserted in pairs are both incorrect.</p>			

⑮ : Selection jumper of input span 10V/5V

The selection to define the input span of all analog inputs of this module. The polarity of this module supports bipolar only. If setting the jumper at 10V position, it means the range of measurement is $\pm 10V/\pm 20mA$ and the temperature range is $-49.8^{\circ}C \sim 146.6^{\circ}C$ (DIN) or $-50.7^{\circ}C \sim 149.2^{\circ}C$ (JIS); if setting the jumper at 5V position, it means the range of measurement is $\pm 5V/\pm 10mA$ and the temperature range is $-12.3^{\circ}C \sim 83.6^{\circ}C$ (DIN) or $-12.5^{\circ}C \sim 85.1^{\circ}C$ (JIS)

Note : FB-2AH(T)4 is fixed at bipolar, without unipolar/bipolar setting!

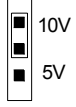
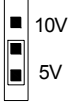
Range		Jumper setting			
		Voltage (V)	Current (I)	-10V~10V	-5V~5V
Span of Analog Input	Voltage (V)			-10V~10V	-5V~5V
	Current (I)			-20mA~20mA	-10mA~10mA
Span of RTD Input	DIN			$-49.8^{\circ}C \sim 146.6^{\circ}C$	$-12.3^{\circ}C \sim 83.6^{\circ}C$
	JIS			$-50.7^{\circ}C \sim 149.2^{\circ}C$	$-12.5^{\circ}C \sim 85.1^{\circ}C$

20.4 Wiring of the temperature modules

20.4.1 Wiring of the J/K thermocouple input module

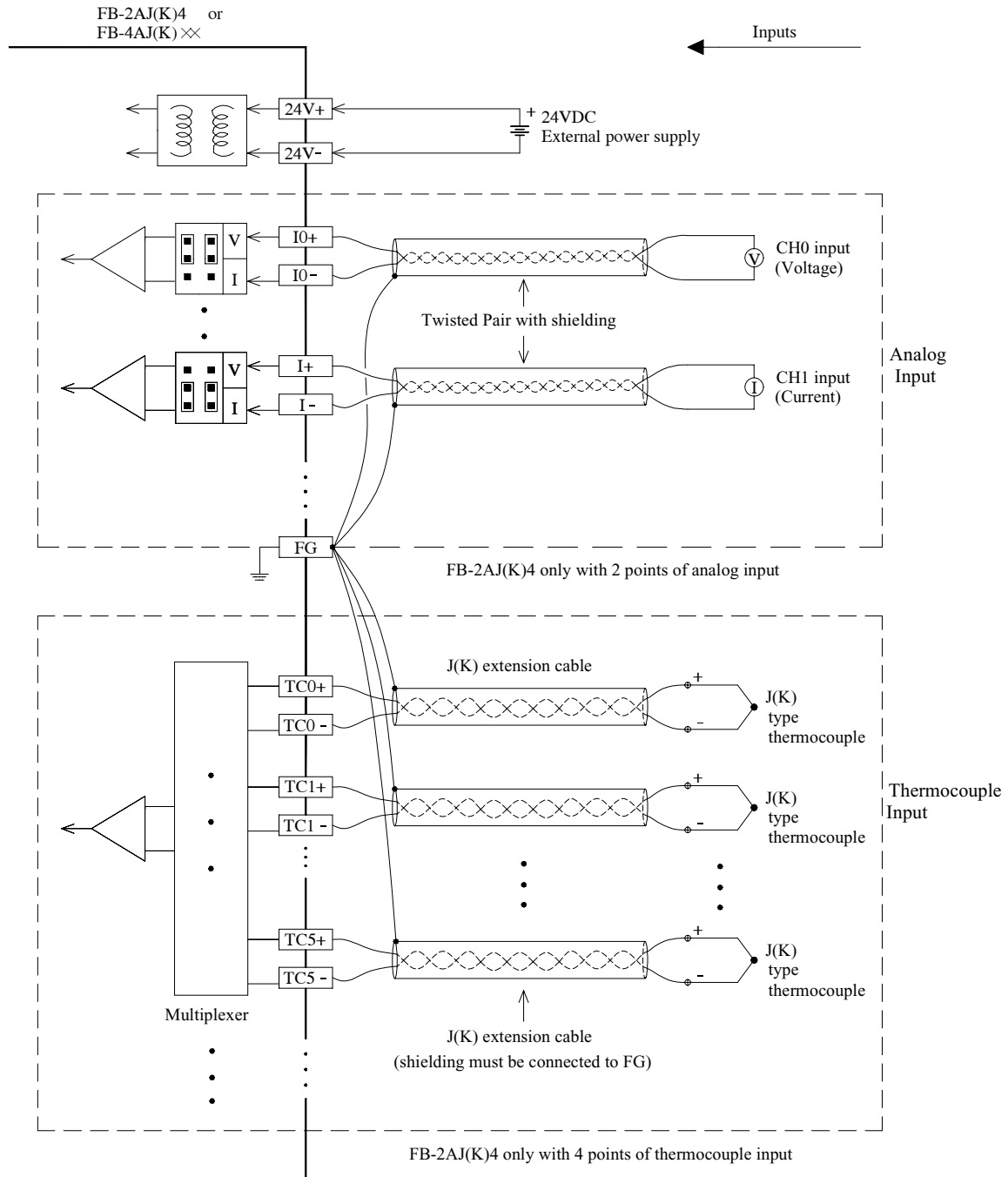

20.4.2 Wiring of 3-wires PT-100/PT-1000 RTD input module

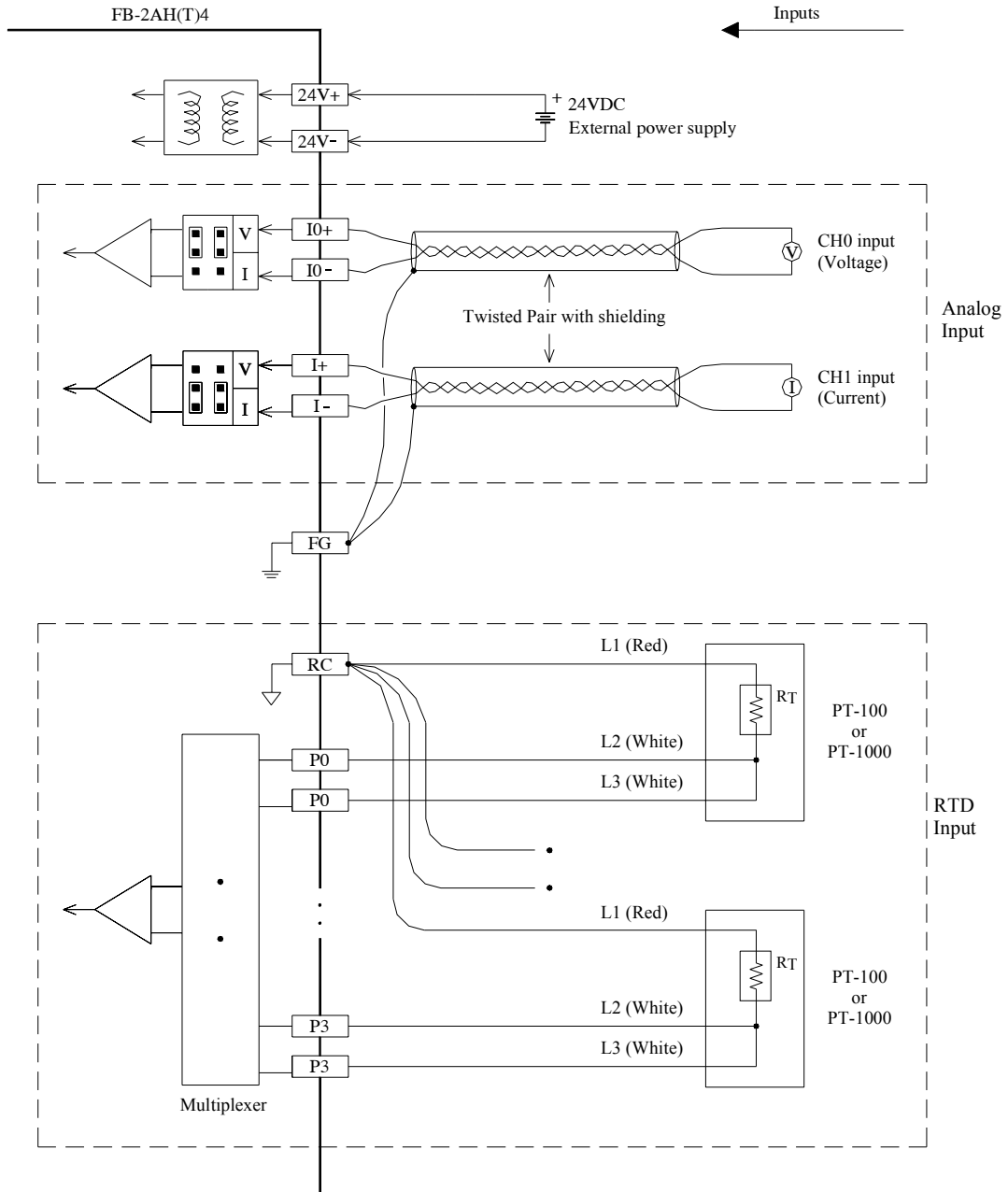

20.5 The input characteristic and jumper setting of temperature module

20.5.1 Temperature module of thermocouple inputs

The characteristics of general purpose analog inputs of FB-2AJ(K)4/FB-4AJ(K)xx are identical to the FB-6AD's. Therefore it will not be explained here, please refer to Chapter 18 for details. This section will only tackle on the subject of temperature measuring. The functions and characters of temperature measurement circuit of FB-4AJ(K)xx are all the same as FB-2AJ(K)4's. The conversion character of which is graphically illustrated as follows. Please note that effective measuring range of J-type thermocouple falls in $-200^{\circ}\text{C}\sim 750^{\circ}\text{C}$, but is $-200^{\circ}\text{C}\sim 900^{\circ}\text{C}$ for K-type. Therefore the marking scale below 200°C and over 750°C or 900°C on the conversion curve does not make sense. Also, it is not possible for temperature to fall below the absolute zero. No matter it's for unipolar/bipolar or $1000^{\circ}\text{C}/500^{\circ}\text{C}$ span, the content of IR (R3840~R3903) at most it can reach 1842. For the scale exceeding 1842, it is treated for line broken check only.

Figure 1: Bipolar 1000°C input span

Jumper setting	10V	B
----------------	-----	---

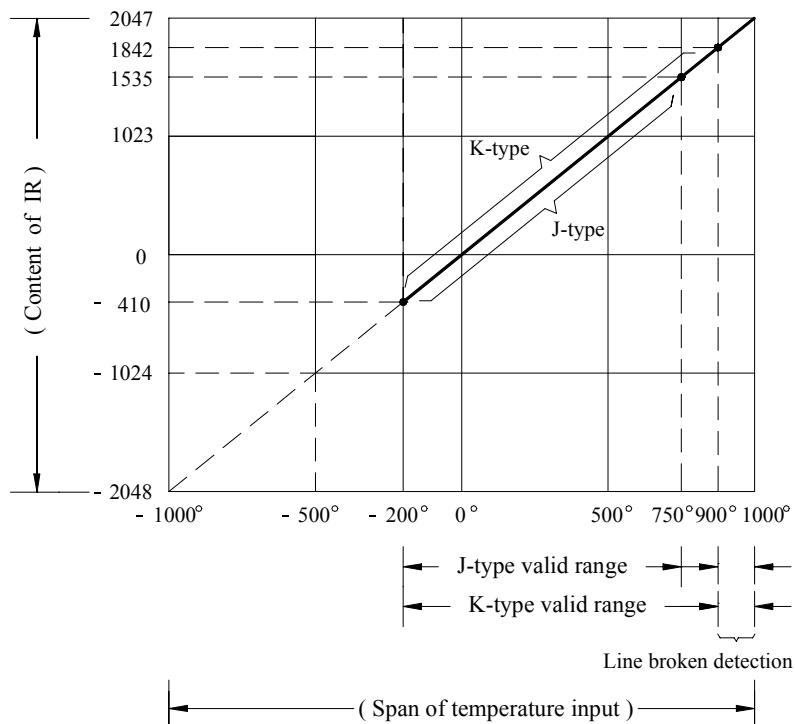

Figure 2: Bipolar 500°C input span

Jumper setting	5V	B
----------------	----	---

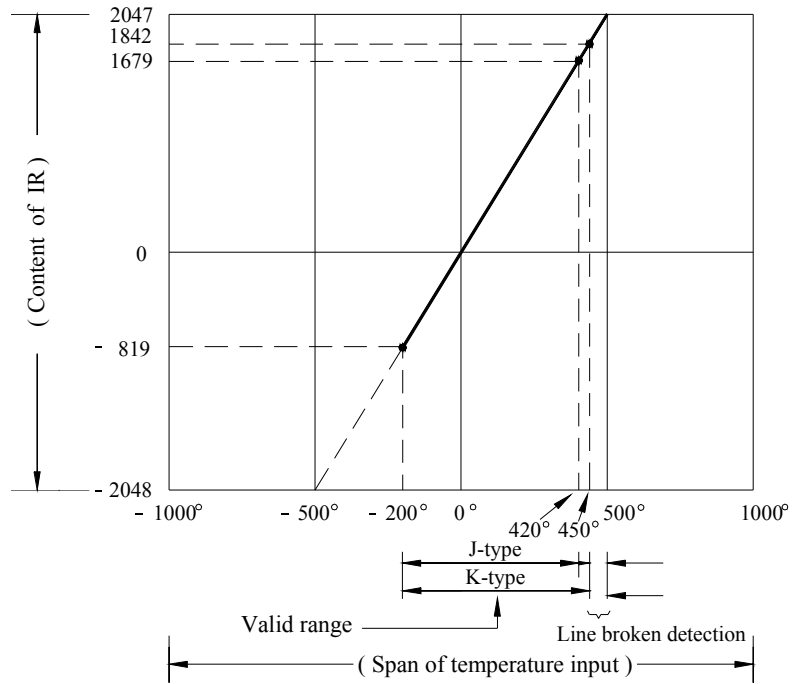

Figure 3: Unipolar 1000°C input span

Jumper Setting	10V	U
----------------	-----	---

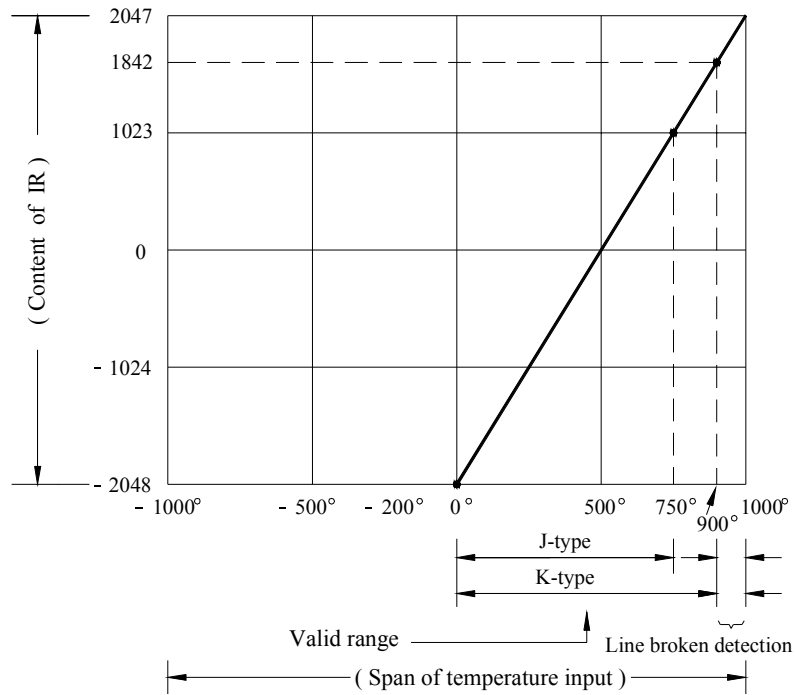
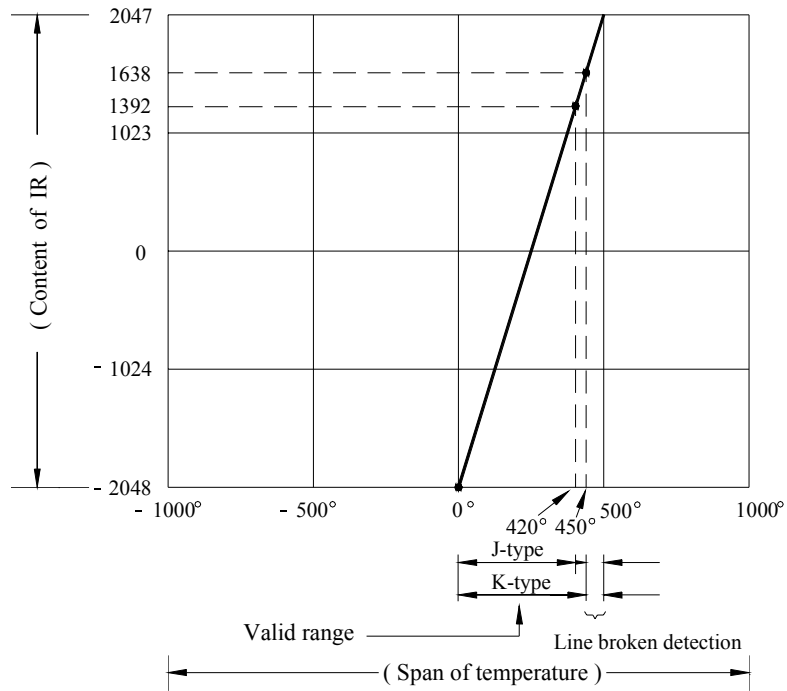

Figure 4: Unipolar 500°C input span

Jumper setting	5V	U
----------------	----	---



20.5.2 Temperature module of 3-wires RTD inputs

The characteristics of general purpose analog inputs of FB-2AH(T)4 are identical to the FB-6AD's. Therefore it will not be explained here, please refer to Chapter 18 for details. This section will only tackle on the subject of temperature measuring. By setting the jumper (JP2) to select the measurement range; if setting the jumper at 10V position, the temperature range is $-49.8^{\circ}\text{C} \sim 146.6^{\circ}\text{C}$ (DIN) or $-50.7^{\circ}\text{C} \sim 149.2^{\circ}\text{C}$ (JIS) and if the jumper at 5V position, the range is $-12.3^{\circ}\text{C} \sim 83.6^{\circ}\text{C}$ (DIN) or $-12.5^{\circ}\text{C} \sim 85.1^{\circ}\text{C}$ (JIS). Please refer to section 20.3.3 for details. The conversion character of this module is illustrated as follows.

Figure 5: Bipolar $-49.8^{\circ}\text{C} \sim 146.6^{\circ}\text{C}$ (DIN) 、 $-50.7^{\circ}\text{C} \sim 149.2^{\circ}\text{C}$ (JIS)

Jumper setting 10V

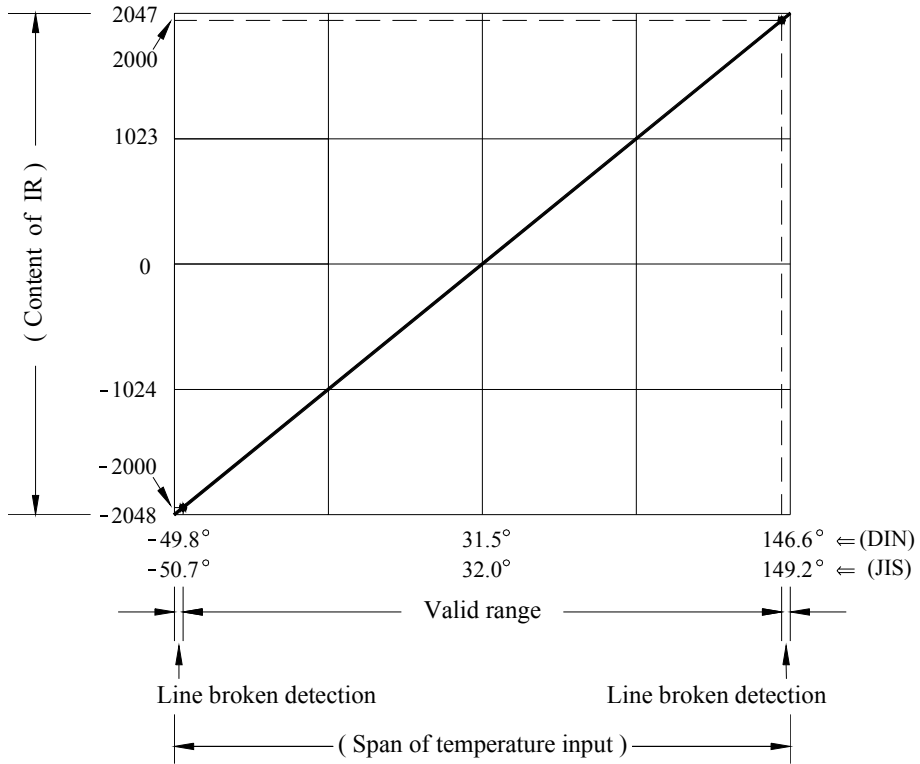
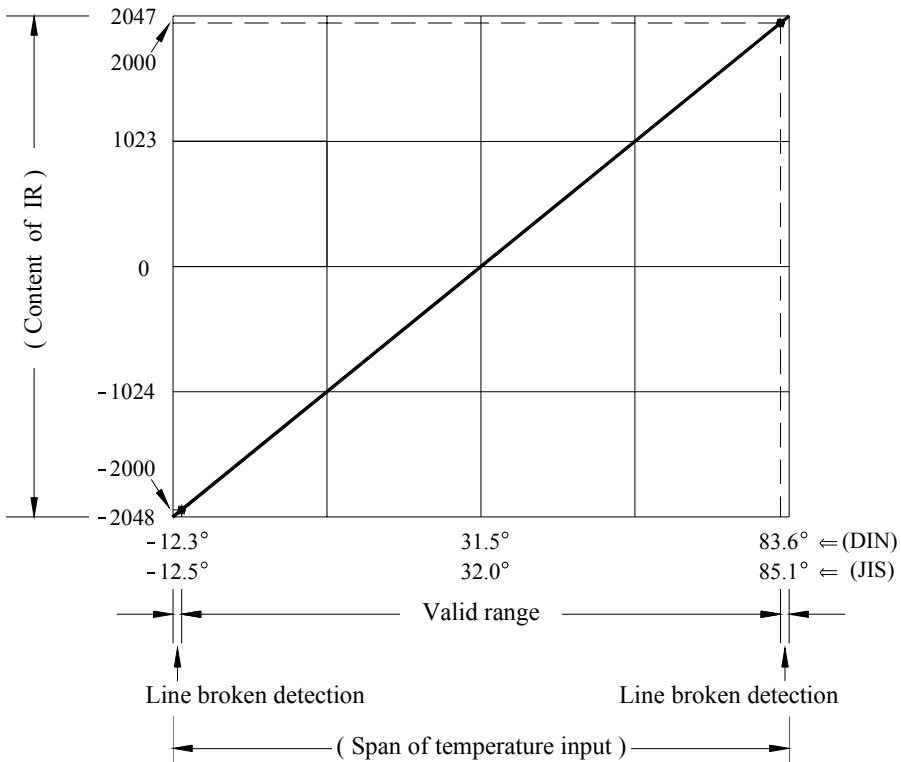

Figure 6: Bipolar $-12.3^{\circ}\text{C} \sim 83.6^{\circ}\text{C}$ (DIN) 、 $-12.5^{\circ}\text{C} \sim 85.1^{\circ}\text{C}$ (JIS)

Jumper setting 5V



20.6 Notifications for the operation of temperature modules

A · Matching with the version of main unit

The temperature measuring module FB-4AJ(K)xx must run under the main unit with OS version V.3.30 or later that it can work correctly.

The temperature measuring modules FB-2AJ(K)4 and FB-2AH(T)4 must run under the main unit with OS version V.3.43 or later that it can work correctly.

Note: To tell the version of the main unit, you can just open up the cover on center of the module and check the sticker bearing print out like

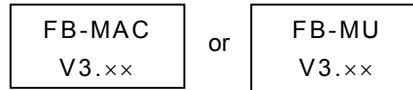

The "V3.xx" indicates the OS version of the main unit.

B · FB-2AJ(K)4/FB-2AH(T)4 can not be used together with FB-4AJ(K)xx module or FB-8AD analog input module.

C · FB-4AJ(K)xx can be installed alone only; it can not exist together with other analog input module or temperature measuring module.

D · The unipolar processing of FB-2AJ(K)4 and FB-4AJ(K)xx

The minimum value (0V or 0mA) for unipolar analog input is expressed as -2048 and maximum value is 2047. For easier processing of the calculation, it is necessary to add up the content of IR (R3840~R3903) with a deviation value of 2048, hence to adjust the unipolar analog input value to be 0~4095.

E · FB-2AH(T)4 only supports bipolar analog input; it means the resolution will be half if the input is unipolar signal

20.7 Instructions explanation and program example for temperature measurement and PID temperature control of FB-PLC

The followings are the instructions explanation and program example for temperature measurement and PID temperature control of FB-PLC.

Measuring instruction proper to FB-2AJ(K)4/FB-2AH(T)4

FUN 72 TP4	Convenient instruction proper to FB-2AJ(K)4/FB-2AH(T)4 temperature module	FUN 72 TP4
---------------	---	---------------

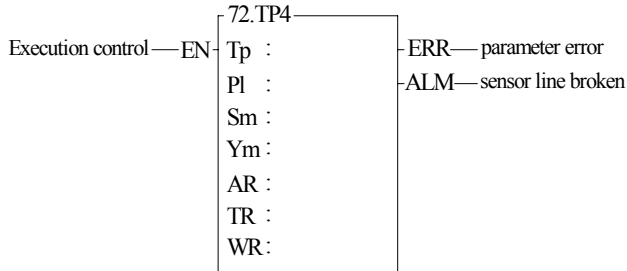

Ope- rand	Y	HR	IR	ROR	DR	K
		Y0 Y255	R0 R3839	R3840 R3903	R5000 R8071	D0 D3071
Tp						0~3
Pl						0~3
Sm						n×4, n=0~7
Ym	○					
AR			○			
TR		○		○*	○	
WR		○		○*	○	

Note1: FUN72 is the convenient instruction dedicated for the multiplexing temperature modules: FB-2AJ4, FB-2AK4, FB-2AH4 and FB-2AT4; each module can perform 4 points of temperature measurement and 2 points of general purpose analog input.

Note2: If only temperature measurement is required, each module must have a corresponding FUN72 instruction to get the engineering value of measurement.

Note3: If temperature control is required, it must employ the FUN73 instruction to perform the temperature measurement and the PID temperature control.

Note4: The FB series PLC can connect up to 8 modules of FB-2AJ(K)4/FB-2AH(T)4, and can perform 32 points of temperature measurement and PID temperature control at the most.

Tp : Type of sensor

- =0, K-type thermocouple
- =1, J-type thermocouple
- =2, PT-100 RTD
- =3, PT-1000 RTD

Pl : Setting of polarity and span

- =0, 0~10V (Unipolar)
- =1, 0~5V (Unipolar)
- =2, -10~10V (Bipolar)
- =3, -5~5V (Bipolar)

Unipolar: U/B jumper set at U
Bipolar: U/B jumper set at B
Span : 5V/10V jumper setting

Sm : Starting point of temperature measurement of this module.

Sm=0, 4, 8, …, 28

Ym : Starting address of discrete output of this module for multiplexing temperature input; it takes 8 points. When expansion module with discrete output will be installed after the temperature module, the discrete output address of which must be added 8.

AR : Address of analog input for temperature measurement of this module; which is the 3rd analog input. When expansion module with analog input will be installed after the temperature module, the analog address of which must be added 3.

TR : Starting register of the engineering value of temperature measurement, 4 registers in total.

WR : Starting of working register for this instruction. It takes 8 registers and can't be repeated in using.

Function guide and notifications

FB-2AJ(K)4/FB-2AH(T)4 multiplexing temperature module occupies 3 points of analog input address and 8 points of discrete output address in physical, more detail as followings:

- FB-2AJ4 provides 2 points of general purpose analog inputs (1st and 2nd analog input) and 4 points of J-type thermocouple inputs for temperature measurement (With the combination of 3rd analog input and 8 points of discrete output making 4 points of temperature measurement).
- FB-2AK4 provides 2 points of general purpose analog inputs (1st and 2nd analog input) and 4 points of K-type thermocouple inputs for temperature measurement (With the combination of 3rd analog input and 8 points of discrete output making 4 points of temperature measurement).
- FB-2AH4 provides 2 points of general purpose analog inputs (1st and 2nd analog input) and 4 points of 3-lines PT-100 RTD inputs for temperature measurement (With the combination of 3rd analog input and 8 points of discrete output making 4 points of temperature measurement).
- FB-2AT4 provides 2 points of general purpose analog inputs (1st and 2nd analog input) and 4 points of 3-lines PT-1000 RTD inputs for temperature measurement (With the combination of 3rd analog input and 8 points of discrete output making 4 points of temperature measurement).

FUN 72 TP4	Convenient instruction proper to FB-2AJ(K)4/FB-2AH(T)4 temperature module	FUN 72 TP4
<ul style="list-style-type: none"> ● The selection of input span of FB-2AJ(K)4 temperature module can be 5V (500°C) (when jumper setting at the position of 5V) or 10V (1000°C)(when jumper setting at the position of 10V); the input polarity can be set as unipolar (U/B jumper setting at U) or bipolar (U/B jumper setting at B): <ul style="list-style-type: none"> When setting at 10V(1000°C) and unipolar, the range of measurement is 0°C~750°C (J-type) or 0°C~900°C (K-type) When setting at 5V(500°C) and unipolar, the range of measurement is 0°C~420°C (J-type) or 0°C~450°C (K-type) When setting at 10V(1000°C) and bipolar, the range of measurement is -200°C~750°C (J-type) or -200°C~900°C(K-type) When setting at 5V(500°C) and bipolar, the range of measurement is -200°C~420°C (J-type) or -200°C~450°C(K-type) ● The selection of input span of FB-2AH(T)4 temperature module can be 5V (when jumper setting at the position of 5V) or 10V (when jumper setting at the position of 10V); the input polarity is fixed for bipolar : <ul style="list-style-type: none"> When setting at 10V, the range of measurement is -49.8°C~146.6°C (DIN) or -50.7°C~149.2°C (JIS) When setting at 5V, the range of measurement is -12.3°C~83.6°C (DIN) or -12.5°C~85.1°C (JIS) ● FB-2AJ(K)4/FB-2AH(T)4 multiplexing temperature module occupies 3 points of analog input address and 8 points of discrete output address in physical; <ul style="list-style-type: none"> • when expansion module with analog input will be installed after this kind of module, the analog address of which must be added 3; • when expansion module with discrete output will be installed after this kind of module, the discrete output address of which must be added 8. ● Modules FB-2AJ(K)4/FB-2AH(T)4 can't be used together with module FB-8AD or FB-4AJ(K)xx. ● For the selection of thermocouple, K-type thermocouple is recommended. ● It is recommended to select 0~5V for the span and polarity of input if it meets the requirement. ● Connect the "FG" terminal with the shielding of thermocouple if it is with for better measurement. ● The "G⊕" terminal must be connected to the safty earth ground of the power system. 		

Measuring instruction proper to FB-2AJ(K)4/FB-2AH(T)4

FUN 72 TP4	Convenient instruction proper to FB-2AJ(K)4/FB-2AH(T)4 temperature module	FUN 72 TP4
<div data-bbox="188 331 738 365" style="border: 1px solid black; padding: 2px;"> <p>User guide for convenient instruction FUN72</p> </div> <p data-bbox="188 383 544 409">FB-2AJ(K)4 temperature module:</p> <ul data-bbox="225 421 1414 607" style="list-style-type: none"> ● When execution control “EN”=1, this instruction will perform multiplexing temperature measurement and store the primitive value into R3968(TP0)~R3971(TP3) or R3972(TP4)~3975(TP7),...or R3996(TP28)~R3999(TP31); the value falls in 0~4095(unipolar) or -2048~2047 (bipolar). And then base on the setting of temperature sensor (Tp), input span and polarity (PI) of the temperature module to scale the primitive values to engineering values and store them to temperature measurement registers (TR+0 as the 1st point, ..., TR+3 as the 4th point). <p data-bbox="188 613 544 640">FB-2AH(T)4 temperature module:</p> <ul data-bbox="225 645 1414 1917" style="list-style-type: none"> ● When execution control “EN”=1, this instruction will perform multiplexing temperature measurement and base on the setting of temperature sensor (Tp), input span and polarity (PI) of the temperature module to scale the primitive values to engineering values and store them to temperature measurement registers (TR+0 as the 1st point, ..., TR+3 as the 4th point). Then scale the engineering values by the range of 0~4095 and store them into R3968(TP0)~R3971(TP3) or R3972(TP4)~3975(TP7),...or R3996(TP28)~R3999(TP31); the value falls in 0~4095. ● When the setting of Tp, PI, Sm comes error, this instruction will not be performed and the output indication “ERR” will be ON. ● When the sensor is K-type thermocouple (it needs FB-2AK4 module): <ol data-bbox="261 949 1414 1290" style="list-style-type: none"> 1.As the setting of input span and polarity is 0~10V, the range of measurement will be 0~900°C. When the display value is greater than 900°C, it means the line broken of the thermocouple and the output indication “ALM” will be ON. 2.As the setting of input span and polarity is 0~5V, the range of measurement will be 0~450°C. When the display value is greater than 450°C, it means the line broken of the thermocouple and the output indication “ALM” will be ON. 3.As the setting of input span and polarity is -10~10V, the range of measurement will be -200~900°C. When the display value is greater than 900°C, it means the line broken of the thermocouple and the output indication “ALM” will be ON. 4.As the setting of input span and polarity is -5~5V, the range of measurement will be -200~450°C. When the display value is greater than 450°C, it means the line broken of the thermocouple and the output indication “ALM” will be ON. ● When the sensor is J-type thermocouple (it needs FB-2AJ4 module): <ol data-bbox="261 1339 1414 1680" style="list-style-type: none"> 1.As the setting of input span and polarity is 0~10V, the range of measurement will be 0~750°C. When the display value is greater than 900°C, it means the line broken of the thermocouple and the output indication “ALM” will be ON. 2.As the setting of input span and polarity is 0~5V, the range of measurement will be 0~420°C. When the display value is greater than 450°C, it means the line broken of the thermocouple and the output indication “ALM” will be ON. 3.As the setting of input span and polarity is -10~10V, the range of measurement will be -200~750°C. When the display value is greater than 900°C, it means the line broken of the thermocouple and the output indication “ALM” will be ON. 4.As the setting of input span and polarity is -5~5V, the range of measurement will be -200~420°C. When the displayed temperature value is greater than 450°C, it means the line broken of the thermocouple and the output indication “ALM” will be ON. ● When the sensor is RTD type of PT-100 (it needs FB-2AH4) or PT-1000 (it needs FB-2AT4): <ol data-bbox="261 1738 1414 1917" style="list-style-type: none"> 1. As the setting of input span is -10~10V, the range of measurement will be -49.8°C~146.6°C (DIN) or -50.7°C~149.2°C (JIS) 2. As the setting of input span is -10~10V, the range of measurement will be -12.3°C~83.6°C (DIN) or -12.5°C~85.1°C (JIS) 3. When the display value is greater than 900.0°C, it means the line broken of the sensor and the output indication “ALM” will be ON. <p data-bbox="233 1957 1414 2018">Note: When there exists the line broken of the sensor, it can be told from the content of WR+0 working register, which tells the input point(s) of line broken.</p>		

FUN 72 TP4	Convenient instruction proper to FB-2AJ(K)4/FB-2AH(T)4 temperature module	FUN 72 TP4
<ul style="list-style-type: none"> ● Sm : Starting point of temperature measurement of this module. It must be the multiple of 4 , $0 \leq Sm \leq 28$. ● Ym : Starting address of discrete output of this module for multiplexing temperature input; it takes 8 points of discrete output. ● AR : Address of analog input (3rd) for temperature measurement of this module. ● TR : Starting register of the engineering value of temperature measurement, 4 registers in total. TR+0 stores the 1st temperature,..., TR+3 stores the 4th temperature. ● WR : Starting of working register for this instruction. It takes 8 registers and can't be repeated in using. The content of WR+0 register indicates the status of the sensor which is line broken or not. Bit definition of WR+0 explained as follows: Bit0 =1 indicating that the 1st point of sensor is line broken; ...; Bit3=1 indicating that the 4th point of sensor is line broken. Registers WR+2~WR+7 are used by this instruction. ● If it only needs to measure temperature, there should be a corresponding FUN72 instruction each for every temperature module to perform the measurement. ● No matter the FUN72 is placed in main program or in sub-program, and whether the execution control "EN"=0 or 1, this instruction must be executed every scan. 		
<div style="border: 1px solid black; padding: 2px; display: inline-block;">Explanation of specific registers for FUN72</div>		
<ul style="list-style-type: none"> ● R3968~R3999 : Registers storing the primitive temperature value. R3968 storing the 1st point, R3969 storing the 2nd point, etc. and R3999 storing the 32th point. The value is from 0~4095 (unipolar) or -2048~2047 (bipolar). ● R4014 : Time interval between the measurement points while multiplexing. Which the user can set up. The unit is in mS and the default value is 500; it means it needs 500 mS to measure one point of temperature. This means the update rate of the temperature is 2 seconds ($500\text{mS} \times 4 = 2000\text{mS}$) When the value of R4014 is 250, it means it needs 250mS to measure one point of temperature. The update rate of the temperature is 1 second ($250\text{mS} \times 4 = 1000\text{mS}$) When the value of R4014 is 1000, it means it needs 1000mS to measure one point of temperature. The update rate of the temperature is 4 seconds ($1000\text{mS} \times 4 = 4000\text{mS}$) When the value of R4014 is 2000, it means it needs 2000mS to measure one point of temperature. The update rate of the temperature is 8 seconds ($2000\text{mS} \times 4 = 8000\text{mS}$) ● R4015 : Times for the average of measurement, which can be set by the user. =0, no average; every acquired value is the measured value (default) =1, average of 2 times; the average on the acquired 2 times of values is the measured value. =2, average of 4 times; the average on the acquired 4 times of values is the measured value. =3, average of 8 times; the average on the acquired 8 times of values is the measured value. =4, average of 16 times; the average on the acquired 16 times of values is the measured value. ● R4016 : The factor for linear scaling to calculate the engineering value of K-type thermocouple while in positive temperature; the default value is 248. The expression for engineering value is as follows: Engineering value = (Primitive temperature value \times R4016) /1024 (Unipolar). Engineering value = (Primitive temperature value $\times 2 \times$ R4016) /1024 (Bipolar). When there is a slight difference in measurement result between the standard meter and the FB-PLC's temperature module, if the user would like to use the value acquired by standard meter for correction, the user can tune the value of R4016 to get a better result in temperature measurement. This register provides fine tuning for positive temperature. ● R4017 : The factor for linear scaling to calculate the engineering value of K-type thermocouple while in negative temperature; the default value is 286. The expression for engineering value is as follows: Engineering value = (Primitive temperature value \times R4017) /1024 (-5~5V). Engineering value = (Primitive temperature value $\times 2 \times$ R4017) /1024 (-10~10V). When there is a slight difference in measurement result between the standard meter and the FB-PLC's temperature module, if the user would like to use the value acquired by standard meter for correction, the user can tune the value of R4017 to get a better result in temperature measurement. This register provides fine tuning for negative temperature. 		

Measuring instruction proper to FB-2AJ(K)4/FB-2AH(T)4

FUN 72 TP4	Convenient instruction proper to FB-2AJ(K)4/FB-2AH(T)4 temperature module	FUN 72 TP4
<ul style="list-style-type: none"> ● R4018 : The factor for linear scaling to calculate the engineering value of J-type thermocouple while in positive temperature; the default value is 240. The expression for engineering value is as follows: Engineering value = (Primitive temperature value ×R4018) /1024 (Unipolar). Engineering value = (Primitive temperature value ×2×R4018) /1024 (Bipolar). When there is a slight difference in measurement result between the standard meter and the FB-PLC's temperature module, if the user would like to use the value acquired by standard meter for correction, the user can tune the value of R4018 to get a better result in temperature measurement. This register provides fine tuning for positive temperature. ● R4019 : The factor for linear scaling to calculate the engineering value of J-type thermocouple while in negative temperature; the default value is 280. The expression for engineering value is as follows: Engineering value = (Primitive temperature value ×R4019) /1024 (-5~5V). Engineering value = (Primitive temperature value ×2×R4019) /1024 (-10~10V). When there is a slight difference in measurement result between the standard meter and the FB-PLC's temperature module, if the user would like to use the value acquired by standard meter for correction, the user can tune the value of R4019 to get a better result in temperature measurement. This register provides fine tuning for negative temperature. ● R4020 : High Byte of R4020 to tell the alpha value of RTD, =0, α=0.00385 (DIN) =1, α=0.00392 (JIS) : Low Byte of R4020 to tell where the registers storing the wire resistance for compensation, =1, the wire resistance for compensation for 3-wires RTD input storing in registers Rxxxx =2, the wire resistance for compensation for 3-wires RTD input storing in registers Dxxxx The starting address of above mentioned registers is storing in R4021. The default of R4020 is 0001H. ● R4021 : Storing the starting address of the registers to store the wire resistance for compensation for 3-wires RTD input; the default of R4021 is 8000, it means the starting register to store the wire resistance for compensation is R8000 by default. The unit of the resistance is 0.1Ω. While in long distance measurement and the accuracy will be affected by the wire resistance of the connection between the RTD sensor and temperature module, under such situation, the user has to measure the wire resistance of each loop and input them to the registers mentioned above; otherwise, forget these. ● R4022 : The factor for linear scaling to calculate the engineering value of PT-100 ; the default value is 1024 The expression for engineering value is as follows: Engineering value = (Primitive temperature value ×R4022) /1024 ● R4023 : The factor for linear scaling to calculate the engineering value of PT-1000 ; the default is 1024 The expression for engineering value is as follows: Engineering value = (Primitive temperature value ×R4023) /1024 When it needs to do the calibration between the standard meter and the FB-PLC's temperature module, the user can tune the value of R4022 or R4023 to get a better result of measurement. ● R4010 : Each bit of R4010 to tell the status of the sensor's installation. Bit0=1 means that 1st point of temperature sensor is installed. Bit1=1 means that 2nd point of temperature sensor is installed. . . Bit15=1 means that 16th point of temperature sensor is installed.(The default of R4010 is FFFFH) ● R4011 : Each bit of R4011 to tell the status of the sensor's installation. Bit0=1 means that 17th point of temperature sensor is installed. Bit1=1 means that 18th point of temperature sensor is installed. . . Bit15=1 means that 32th point of temperature sensor is installed. (The default of R4011 is FFFFH) ● When the temperature sensor is installed (the corresponding bit of R4010 or R4011 must be 1), the system will perform the line broken detection to the sensor. If there is line broken happened to the sensor, there will have the warning and the line broken value will be displayed. ● When the temperature sensor is not installed (the corresponding bit of R4010 or R4011 must be 0), the system won't perform the line broken detection to the sensor and there will not have the warning; the temperature value will be displayed as 0. ● Depends on the sensor's installation, the ladder program may control the corresponding bit of R4010 and R4011 to tell FUN72 to perform or not to perform the line broken detection. 		

FUN 72 TP4	Convenient instruction proper to FB-2AJ(K)4/FB-2AH(T)4 temperature module	FUN 72 TP4
---------------	---	---------------

Program example 1

The main unit is FBx-28MC(A), the FB-2AK4 temperature module is attached to the main unit, and the FB-2AJ4 temperature module is attached to FB-2AK4 module. The setting of polarity and span are 0~10V for both of temperature modules.

- ※ The analog input address for temperature measurement of FB-2AK4 is R3842.
- ※ The analog input address for temperature measurement of FB-2AJ4 is R3845.

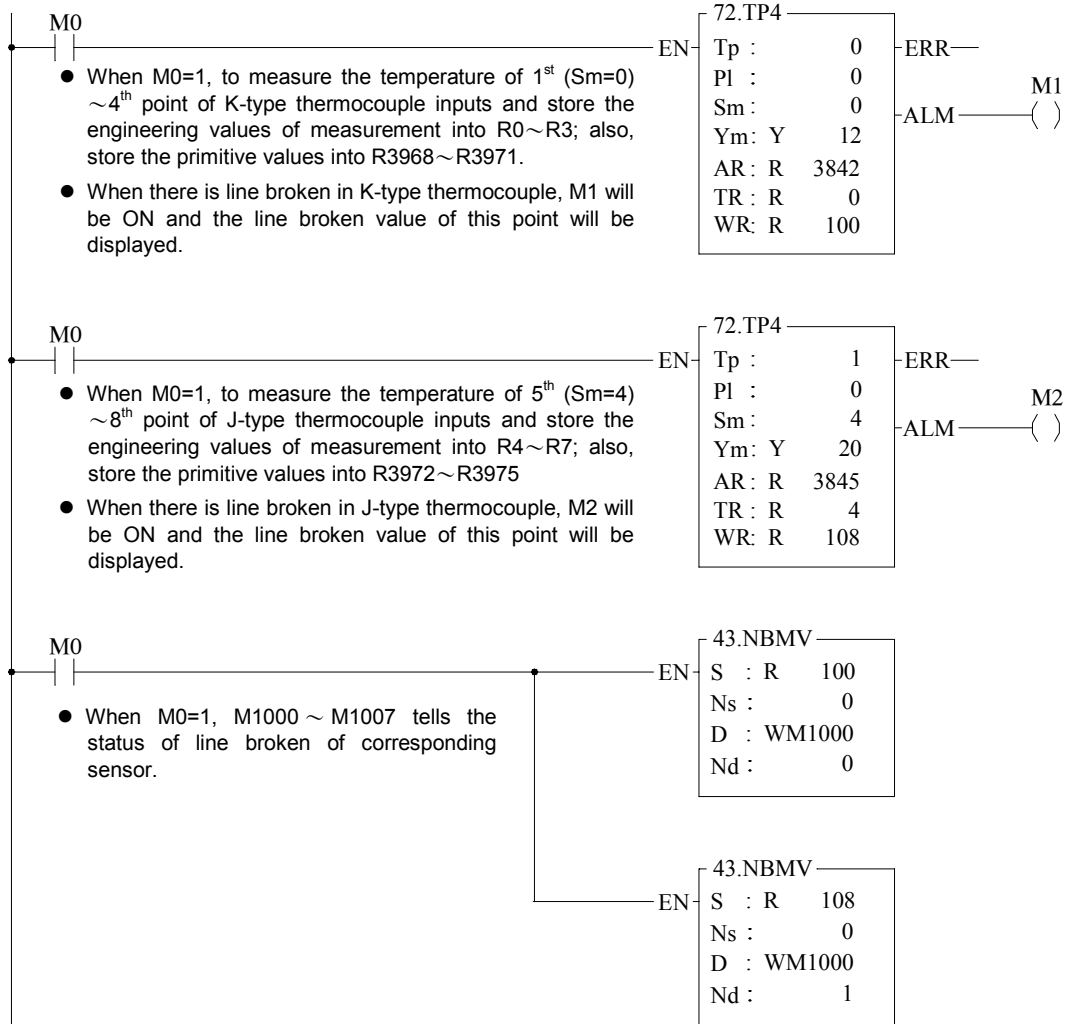

Measuring instruction proper to FB-2AJ(K)4/FB-2AH(T)4

FUN 72 TP4	Convenient instruction proper to FB-2AJ(K)4/FB-2AH(T)4 temperature module	FUN 72 TP4
---------------	---	---------------

Program example 2

The main unit is FBx-28MC(A), the FB-2AH4 temperature module is attached to the main unit, and the FB-2AT4 temperature module is attached to FB-2AH4 module. The spans are setting at 10V for both of temperature modules. (The polarity is fixed at bipolar).

- ※ The analog input address for temperature measurement of FB-2AH4 is R3842.
- ※ The analog input address for temperature measurement of FB-2AT4 is R3845.

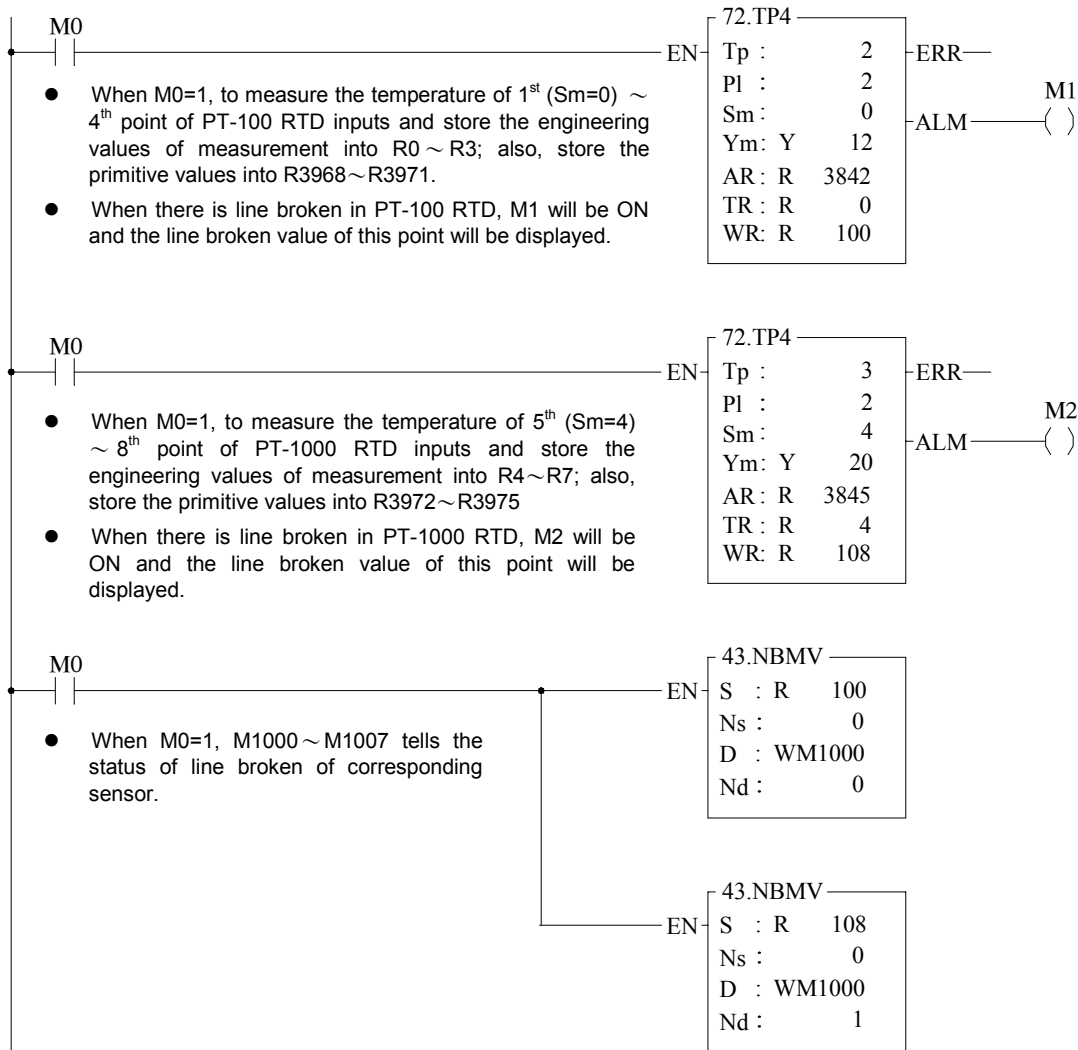

FUN 72 TP4	Convenient instruction proper to FB-2AJ(K)4/FB-2AH(T)4 temperature module	FUN 72 TP4
<p>Program example 3 The main unit is FBx-40MC(A), and 4 modules of FB-2AK4 are attached. The setting of span and polarity are all at 0~5V.</p>		
<p>M0</p>	<ul style="list-style-type: none"> ● The status of M800~M831 are controlled by the MMI or external inputs to tell the status of sensor's installation; if it has the sensor, perform line broken detection, and not to perform the check if it hasn't. (It needs the retentive function, so M800~M1399 are the better choice). 	<pre> 08D.MOV S : WM 800 D : R 4010 </pre>
<p>M0</p>	<ul style="list-style-type: none"> ● When M0=1, to measure the temperature of 1st (Sm=0) ~ 4th point of K-type thermocouple inputs and store the engineering values of measurement into R0~R3; also, store the primitive values into R3968~R3971. ● When there is line broken of the sensor, the value of line broken will be displayed. 	<pre> 72.TP4 Tp : 0 ERR— Pl : 1 Sm : 0 ALM— Ym: Y 16 AR: R 3842 TR: R 0 WR: R 100 </pre>
<p>M0</p>	<ul style="list-style-type: none"> ● When M0=1, to measure the temperature of 5th (Sm=4) ~ 8th point of K-type thermocouple inputs and store the engineering values of measurement into R4~R7; also, store the primitive values into R3972~R3975. ● When there is line broken of the sensor, the value of line broken will be displayed. 	<pre> 72.TP4 Tp : 0 ERR— Pl : 1 Sm : 4 ALM— Ym: Y 24 AR: R 3845 TR: R 4 WR: R 108 </pre>
<p>M0</p>	<ul style="list-style-type: none"> ● When M0=1, to measure the temperature of 9th (Sm=8) ~ 12th point of K-type thermocouple inputs and store the engineering values of measurement into R8~R11; also, store the primitive values into R3976~R3979. ● When there is line broken of the sensor, the value of line broken will be displayed. 	<pre> 72.TP4 Tp : 0 ERR— Pl : 1 Sm : 8 ALM— Ym: Y 32 AR: R 3848 TR: R 8 WR: R 116 </pre>
<p>M0</p>	<ul style="list-style-type: none"> ● When M0=1, to measure the temperature of 13th (Sm=12) ~ 16th point of K-type thermocouple inputs and store the engineering values of measurement into R12~R15; also, store the primitive values into R3980~R3983. ● When there is line broken of the sensor, the value of line broken will be displayed. 	<pre> 72.TP4 Tp : 0 ERR— Pl : 1 Sm : 12 ALM— Ym: Y 40 AR: R 3851 TR: R 12 WR: R 124 </pre>
<p>M0</p>	<ul style="list-style-type: none"> ● When M0=1, M1000~M1015 tells the line broken status of corresponding sensor. 	<pre> 43.NBMV S : R 100 Ns : 0 D : WM 1000 Nd : 0 </pre>
		<pre> 43.NBMV S : R 108 Ns : 0 D : WM 1000 Nd : 1 </pre>
		<pre> 43.NBMV S : R 116 Ns : 0 D : WM 1000 Nd : 2 </pre>
		<pre> 43.NBMV S : R 124 Ns : 0 D : WM 1000 Nd : 3 </pre>

Measuring instruction proper to FB-2AJ(K)4/FB-2AH(T)4

FUN 72 TP4	Convenient instruction proper to FB-2AJ(K)4/FB-2AH(T)4 temperature module	FUN 72 TP4																																																																
<p>Program example 4 The main unit is FBx-40MC(A), and 4 modules of FB-2AH4 are attached. The spans are all setting at 5V (FB-2AH4 supports bipolar only).</p>																																																																		
<p>M0</p>	<ul style="list-style-type: none"> The status of M800~M831 are controlled by the MMI or external inputs to tell the status of sensor's installation; if it has the sensor, perform line broken detection, and not to perform the check if it hasn't. (It needs the retentive function, so M800~M1399 are the better choice). 	<p>08D.MOV</p> <table border="1"> <tr><td>S</td><td>: WM</td><td>800</td></tr> <tr><td>D</td><td>: R</td><td>4010</td></tr> </table>	S	: WM	800	D	: R	4010																																																										
S	: WM	800																																																																
D	: R	4010																																																																
<p>M0</p>	<ul style="list-style-type: none"> When M0=1, to measure the temperature of 1st (Sm=0) ~4th point of PT-100 RTD inputs and store the engineering values of measurement into R0~R3; also, store the primitive values into R3968~R3971. When there is line broken of the sensor, the value of line broken will be displayed. 	<p>72.TP4</p> <table border="1"> <tr><td>ERR</td><td>—</td><td>2</td></tr> <tr><td>Pl</td><td>:</td><td>3</td></tr> <tr><td>Sm</td><td>:</td><td>0</td></tr> <tr><td>ALM</td><td>—</td><td>16</td></tr> <tr><td>Ym</td><td>: Y</td><td>3842</td></tr> <tr><td>AR</td><td>: R</td><td>0</td></tr> <tr><td>TR</td><td>: R</td><td>100</td></tr> <tr><td>WR</td><td>: R</td><td></td></tr> </table>	ERR	—	2	Pl	:	3	Sm	:	0	ALM	—	16	Ym	: Y	3842	AR	: R	0	TR	: R	100	WR	: R																																									
ERR	—	2																																																																
Pl	:	3																																																																
Sm	:	0																																																																
ALM	—	16																																																																
Ym	: Y	3842																																																																
AR	: R	0																																																																
TR	: R	100																																																																
WR	: R																																																																	
<p>M0</p>	<ul style="list-style-type: none"> When M0=1, to measure the temperature of 5th (Sm=4) ~8th point of PT-100 RTD inputs and store the engineering values of measurement into R4~R7; also, store the primitive values into R3972~R3975. When there is line broken of the sensor, the value of line broken will be displayed. 	<p>72.TP4</p> <table border="1"> <tr><td>ERR</td><td>—</td><td>2</td></tr> <tr><td>Pl</td><td>:</td><td>3</td></tr> <tr><td>Sm</td><td>:</td><td>4</td></tr> <tr><td>ALM</td><td>—</td><td>24</td></tr> <tr><td>Ym</td><td>: Y</td><td>3845</td></tr> <tr><td>AR</td><td>: R</td><td>4</td></tr> <tr><td>TR</td><td>: R</td><td>108</td></tr> <tr><td>WR</td><td>: R</td><td></td></tr> </table>	ERR	—	2	Pl	:	3	Sm	:	4	ALM	—	24	Ym	: Y	3845	AR	: R	4	TR	: R	108	WR	: R																																									
ERR	—	2																																																																
Pl	:	3																																																																
Sm	:	4																																																																
ALM	—	24																																																																
Ym	: Y	3845																																																																
AR	: R	4																																																																
TR	: R	108																																																																
WR	: R																																																																	
<p>M0</p>	<ul style="list-style-type: none"> When M0=1, to measure the temperature of 9th (Sm=8) ~12th point of PT-100 RTD inputs and store the engineering values of measurement into R8~R11; also, store the primitive values into R3976~R3979. When there is line broken of the sensor, the value of line broken will be displayed. 	<p>72.TP4</p> <table border="1"> <tr><td>ERR</td><td>—</td><td>2</td></tr> <tr><td>Pl</td><td>:</td><td>3</td></tr> <tr><td>Sm</td><td>:</td><td>8</td></tr> <tr><td>ALM</td><td>—</td><td>32</td></tr> <tr><td>Ym</td><td>: Y</td><td>3848</td></tr> <tr><td>AR</td><td>: R</td><td>8</td></tr> <tr><td>TR</td><td>: R</td><td>116</td></tr> <tr><td>WR</td><td>: R</td><td></td></tr> </table>	ERR	—	2	Pl	:	3	Sm	:	8	ALM	—	32	Ym	: Y	3848	AR	: R	8	TR	: R	116	WR	: R																																									
ERR	—	2																																																																
Pl	:	3																																																																
Sm	:	8																																																																
ALM	—	32																																																																
Ym	: Y	3848																																																																
AR	: R	8																																																																
TR	: R	116																																																																
WR	: R																																																																	
<p>M0</p>	<ul style="list-style-type: none"> When M0=1, to measure the temperature of 13th (sm=12) ~16th point of PT-100 RTD inputs and store the engineering values of measurement into R12~R15; also, store the primitive values into R3980~R3983. When there is line broken of the sensor, the value of line broken will be displayed. 	<p>72.TP4</p> <table border="1"> <tr><td>ERR</td><td>—</td><td>2</td></tr> <tr><td>Pl</td><td>:</td><td>3</td></tr> <tr><td>Sm</td><td>:</td><td>12</td></tr> <tr><td>ALM</td><td>—</td><td>40</td></tr> <tr><td>Ym</td><td>: Y</td><td>3851</td></tr> <tr><td>AR</td><td>: R</td><td>12</td></tr> <tr><td>TR</td><td>: R</td><td>124</td></tr> <tr><td>WR</td><td>: R</td><td></td></tr> </table>	ERR	—	2	Pl	:	3	Sm	:	12	ALM	—	40	Ym	: Y	3851	AR	: R	12	TR	: R	124	WR	: R																																									
ERR	—	2																																																																
Pl	:	3																																																																
Sm	:	12																																																																
ALM	—	40																																																																
Ym	: Y	3851																																																																
AR	: R	12																																																																
TR	: R	124																																																																
WR	: R																																																																	
<p>M0</p>	<ul style="list-style-type: none"> When M0=1, M1000~M1015 tells the line broken status of corresponding sensor. 	<table border="1"> <tr><td>EN</td><td>43.NBMV</td><td>S : R</td><td>100</td></tr> <tr><td></td><td></td><td>Ns :</td><td>0</td></tr> <tr><td></td><td></td><td>D : WM</td><td>1000</td></tr> <tr><td></td><td></td><td>Nd :</td><td>0</td></tr> </table> <table border="1"> <tr><td>EN</td><td>43.NBMV</td><td>S : R</td><td>108</td></tr> <tr><td></td><td></td><td>Ns :</td><td>0</td></tr> <tr><td></td><td></td><td>D : WM</td><td>1000</td></tr> <tr><td></td><td></td><td>Nd :</td><td>1</td></tr> </table> <table border="1"> <tr><td>EN</td><td>43.NBMV</td><td>S : R</td><td>116</td></tr> <tr><td></td><td></td><td>Ns :</td><td>0</td></tr> <tr><td></td><td></td><td>D : WM</td><td>1000</td></tr> <tr><td></td><td></td><td>Nd :</td><td>2</td></tr> </table> <table border="1"> <tr><td>EN</td><td>43.NBMV</td><td>S : R</td><td>124</td></tr> <tr><td></td><td></td><td>Ns :</td><td>0</td></tr> <tr><td></td><td></td><td>D : WM</td><td>1000</td></tr> <tr><td></td><td></td><td>Nd :</td><td>3</td></tr> </table>	EN	43.NBMV	S : R	100			Ns :	0			D : WM	1000			Nd :	0	EN	43.NBMV	S : R	108			Ns :	0			D : WM	1000			Nd :	1	EN	43.NBMV	S : R	116			Ns :	0			D : WM	1000			Nd :	2	EN	43.NBMV	S : R	124			Ns :	0			D : WM	1000			Nd :	3
EN	43.NBMV	S : R	100																																																															
		Ns :	0																																																															
		D : WM	1000																																																															
		Nd :	0																																																															
EN	43.NBMV	S : R	108																																																															
		Ns :	0																																																															
		D : WM	1000																																																															
		Nd :	1																																																															
EN	43.NBMV	S : R	116																																																															
		Ns :	0																																																															
		D : WM	1000																																																															
		Nd :	2																																																															
EN	43.NBMV	S : R	124																																																															
		Ns :	0																																																															
		D : WM	1000																																																															
		Nd :	3																																																															

FUN 73 TSTC	Convenient instruction of PID temperature control for FB-2AJ(K)4/FB-2AH(T)4	FUN 73 TSTC
----------------	---	----------------

Execution control—EN	73.TSTC	ERR— Parameter error
Heating/Cooling—H/C	Tp :	AO0— Sensor line broken
	Pl :	AO1— Warning indication
	Sm :	
	Ym :	
	AR :	
	TR :	
	Yh :	
	Sh :	
	Zh :	
	Sv :	
	Os :	
	PR :	
	IR :	
	DR :	
	OR :	
	WR :	

Tp : Type of sensor
 =0, K-type thermocouple
 =1, J-type thermocouple
 =2, PT-100 RTD
 =3, PT-1000 RTD
 Pl : Setting of polarity and span
 =0, 0 ~ 10V (Unipolar)
 =1, 0 ~ 5V (Unipolar)
 =2, -10 ~ 10V (Bipolar)
 =3, -5 ~ 5V (Bipolar)
 Unipolar: U/B jumper set at U
 Bipolar: U/B jumper set at B
 Span : 5V/10V jumper setting

Sm : Starting point of temperature measurement of this module.
 Sm=0, 4, 8....., 28

Ym : Starting address of discrete output of this module for multiplexing temperature input; it takes 8 points. When expansion module with discrete output will be installed after the temperature module, the discrete output address of which must be added 8.

AR : Address of analog input for temperature measurement of this module; which is the 3rd analog input. When expansion module with analog input will be installed after the temperature module, the analog address of which must be added 3.

TR : Starting register of the engineering value of temperature measurement, 4 registers in total.

Yh : Starting address of PID ON/OFF output; it takes Zh points.

Sh : Starting point of PID control of this instruction; Sh = 0~31.

Zh : Number of the PID control of this instruction; 1≤Zh≤32 and 1≤Sh+Zh≤32

Sv : Starting register of the setpoint; it takes Zh registers.

Os : Starting register of the in-zone offset; it takes Zh registers.

PR : Starting register of the gain (Kc); it takes Zh registers.

IR : Starting register of integral tuning constant (Ti); it takes Zh registers.

DR : Starting register of derivative tuning constant (Td); it takes Zh registers.

OR : Starting register of the PID analog output; it takes Zh registers.

WR : Starting of working register for this instruction. It takes 17 registers and can't be repeated in using.

Range	Y	HR	IR	DR	ROR	K
Ope- rand	Y0 Y255	R0 R3839	R3840 R3903	D0 D3071	R5000 R8071	
Tp						0~3
Pl						0~3
Sm						n × 4 n=0~7
Ym	○					
AR			○			
TR		○		○	○*	
Yh	○					
Sh						0~31
Zh						1~32
Sv		○		○	○*	
Os		○		○	○*	
PR		○		○	○*	
IR		○		○	○*	
DR		○		○	○*	
OR		○		○	○*	
WR		○		○	○*	

FUN 73 TSTC	Convenient instruction of PID temperature control for FB-2AJ(K)4/FB-2AH(T)4	FUN 73 TSTC
<div style="border: 1px solid black; padding: 5px; margin-bottom: 10px;">Function guide and notifications</div> <ul style="list-style-type: none"> ● FUN73 Convenient instruction combines the temperature measurement with PID control and it is dedicated for the modules of FB-2AJ(K)4 and FB-2AH(T)4. ● FB-2AJ(K)4/FB-2AH(T)4 multiplexing temperature module occupies 3 points of analog input address and 8 points of discrete output address in physical, more detail as followings: <ul style="list-style-type: none"> ● FB-2AJ4 provides 2 points of general purpose analog inputs (1st and 2nd analog input) and 4 points of J-type thermocouple inputs for temperature measurement (With the combination of 3rd analog input and 8 points of discrete output making 4 points of temperature measurement). ● FB-2AK4 provides 2 points of general purpose analog inputs (1st and 2nd analog input) and 4 points of K-type thermocouple inputs for temperature measurement (With the combination of 3rd analog input and 8 points of discrete output making 4 points of temperature measurement). ● FB-2AH4 provides 2 points of general purpose analog inputs (1st and 2nd analog input) and 4 points of 3-lines PT-100 RTD inputs for temperature measurement (With the combination of 3rd analog input and 8 points of discrete output making 4 points of temperature measurement). ● FB-2AT4 provides 2 points of general purpose analog inputs (1st and 2nd analog input) and 4 points of 3-lines PT-1000 RTD inputs for temperature measurement (With the combination of 3rd analog input and 8 points of discrete output making 4 points of temperature measurement). ● The selection of input span of FB-2AJ(K)4 temperature module can be 5V (500°C) (when jumper setting at the position of 5V) or 10V (1000°C)(when jumper setting at the position of 10V); the input polarity can be set as unipolar (U/B jumper setting at U) or bipolar (U/B jumper setting at B): <ul style="list-style-type: none"> When setting at 10V(1000°C) and unipolar, the range of measurement is 0°C~750°C (J-type) or 0°C~900°C (K-type) When setting at 5V(500°C) and unipolar, the range of measurement is 0°C~420°C (J-type) or 0°C~450°C (K-type) When setting at 10V(1000°C) and bipolar, the range of measurement is -200°C~750°C (J-type) or -200°C~900°C(K-type) When setting at 5V(500°C) and bipolar, the range of measurement is -200°C~420°C (J-type) or -200°C~450°C(K-type) ● The selection of input span of FB-2AH(T)4 temperature module can be 5V (when jumper setting at the position of 5V) or 10V (when jumper setting at the position of 10V); the input polarity is fixed for bipolar : <ul style="list-style-type: none"> When setting at 10V, the range of measurement is -49.8°C~146.6°C (DIN) or -50.7°C~149.2°C (JIS) When setting at 5V, the range of measurement is -12.3°C~83.6°C (DIN) or -12.5°C~85.1°C (JIS) ● FB-2AJ(K)4/FB-2AH(T)4 multiplexing temperature module occupies 3 points of analog input address and 8 points of discrete output address in physical; <ul style="list-style-type: none"> • when expansion module with analog input will be installed after this kind of module, the analog address of which must be added 3; • when expansion module with discrete output will be installed after this kind of module, the discrete output address of which must be added 8. ● Modules FB-2AJ(K)4/FB-2AH(T)4 can't be used together with module FB-8AD or FB-4AJ(K)××. ● For the selection of thermocouple, K-type thermocouple is recommended. ● It is recommended to select 0~5V for the span and polarity of input if it meets the requirement. ● Connect the "FG" terminal with the shielding of thermocouple if it is with for better measurement. ● The "G⊕" terminal must be connected to the safty earth ground of the power system. 		

FUN 73 TSTC	Convenient instruction of PID temperature control for FB-2AJ(K)4/FB-2AH(T)4	FUN 73 TSTC
<p>● Fun73 instruction employs the multiplexing temperature module [FB-2AJ(K)4/FB-2AH(T)4] to get the current value of temperature and let it be as so called Process Variable (PV); after the calculation of software PID expression, it will respond the error with an output signal according to the setting of Set Point (SP), the error's integral and the rate of change of the process variable. Through the closed loop operation, the steady state of the process may be expected.</p> <p>● Convert the output of PID calculation to be the time proportional on/off (PWM) output, and via transistor output to control the SSR for heating or cooling process; this is a good performance and very low cost solution.</p> <p>● Through the analog output module (D/A module), the output of PID calculation may control the SCR or proportional valve to get more precise process control.</p> <p>● Digitized PID expression is as follows:</p> $M_n = [K_c \times E_n] + \sum_0^n [K_c \times T_i \times T_s \times E_n] - [K_c \times T_d \times (PV_n - PV_{n-1}) / T_s]$ <p>Where,</p> <p>M_n : Output at time "n".</p> <p>K_c : Gain (Range: 1~999 ; P_b=100%) / K_c)</p> <p>T_i : Integral tuning constant (Range:0~999, equivalent to 0.00~9.99 Repeat/Minute)</p> <p>T_d : Derivative tuning constant (Range:0~999, equivalent to 0.00~9.99 Minute)</p> <p>PV_n: Process variable at time "n"</p> <p>PV_{n-1}: Process variable when loop was last solved</p> <p>E_n : Error at time "n" ; E= SP – PV_n</p> <p>T_s : Solution interval for PID calculation (Valid value are 10, 20, 40, 80 ;the unit is in 0.1Sec)</p>		

FUN 73 TSTC	Convenient instruction of PID temperature control for FB-2AJ(K)4/FB-2AH(T)4	FUN 73 TSTC
----------------	---	----------------

Principle of PID parameter adjustment

- As the gain (Kc) adjustment getting larger, the larger the proportional contribution to the output. This can obtain a sensitive and rapid control reaction. However, when the gain is too large, it may cause oscillation. Do the best to adjust “Kc” larger (but not to the extent of making oscillation), which could increase the process reaction and reduce the steady state error.
- Integral item may be used to eliminate the steady state error. The larger the number (Ti, integral tuning constant), the larger the integral contribution to the output. When there is steady state error, adjust the “Ti” larger to decrease the error.
When the “Ti” = 0, the integral item makes no contribution to the output.
For exa, if the reset time is 6 minutes, $Ti=100/6=17$; if the integral time is 5 minutes, $Ti=100/5=20$.
- Derivative item may be used to make the process smoother and not too over shoot. The larger the number (Td, derivative tuning constant), the larger the derivative contribution to the output. When there is too over shoot, adjust the “Td” larger to decrease the amount of over shoot.
When the “Td” = 0, the derivative item makes no contribution to the output.
For exa, if the rate time is 1 minute, then the $Td = 100$; if the differential time is 2 minute, then the $Td = 200$.
- Properly adjust the PID parameters can obtain an excellent result for temperature control.
- The default of gain value (Kc) is as follows:
When the setting of span and polarity of the module is 0~10V, the default of gain (Kc) is 60.
When the setting of span and polarity of the module is 0~5V, the default of gain (Kc) is 30.
When the setting of span and polarity of the module is -10~10V, the default of gain (Kc) is 120.
When the setting of span and polarity of the module is -5~5V, the default of gain (Kc) is 60.
- The default of integral tuning constant is 17, it mens the reset time is 6 minutes ($Ti=100/6=17$).
- The default of derivative tuning constant is 100, it means the rate time is 1 minutes ($Td=100$).

User guide to Convenient instruction FUN73

FB-2AJ(K)4 temperature module:

- When execution control “EN”=1, this instruction will perform multiplexing temperature measurement and store the primitive value into R3968(TP0)~R3971(TP3) or R3972(TP4)~3975(TP7),...or R3996(TP28)~R3999(TP31); the value falls in 0~4095(unipolar) or -2048~2047 (bipolar). And then base on the setting of temperature sensor (Tp), input span and polarity (PI) of the temperature module to scale the primitive values to engineering values and store them to temperature measurement registers (TR+0 as the 1st point, ..., TR+3 as the 4th point).

FB-2AH(T)4 temperature module:

- When execution control “EN”=1, this instruction will perform multiplexing temperature measurement and base on the setting of temperature sensor (Tp), input span and polarity (PI) of the temperature module to scale the primitive values to engineering values and store them to temperature measurement registers (TR+0 as the 1st point, ..., TR+3 as the 4th point). Then scale the engineering values by the range of 0~4095 and store them into R3968(TP0)~R3971(TP3) or R3972(TP4)~3975(TP7),...or R3996(TP28)~R3999(TP31); the value falls in 0~4095.
- When the setting of Tp, PI, Sm comes error, this instruction will not be performed and the output indication “ERR” will be ON.
- When the sensor is K-type thermocouple (it needs FB-2AK4 module):
 1. As the setting of input span and polarity is 0~10V, the range of measurement will be 0~900°C.
When the display value is greater than 900°C, it means the line broken of the thermocouple and the output indication “AO0” will be ON.
 2. As the setting of input span and polarity is 0~5V, the range of measurement will be 0~450°C.
When the display value is greater than 450°C, it means the line broken of the thermocouple and the output indication “AO0” will be ON.
 3. As the setting of input span and polarity is -10~10V, the range of measurement will be -200~900°C.
When the display value is greater than 900°C, it means the line broken of the thermocouple and the output indication “AO0” will be ON.
 4. As the setting of input span and polarity is -5~5V, the range of measurement will be -200~450°C.
When the display value is greater than 450°C, it means the line broken of the thermocouple and the output indication “AO0” will be ON.

FUN 73 TSTC	Convenient instruction of PID temperature control for FB-2AJ(K)4/FB-2AH(T)4	FUN 73 TSTC
<ul style="list-style-type: none"> ● When the sensor is J-type thermocouple (it needs FB-2AJ4 module): <ol style="list-style-type: none"> 1. As the setting of input span and polarity is 0~10V, the range of measurement will be 0~750°C. When the display value is greater than 900°C, it means the line broken of the thermocouple and the output indication "AO0" will be ON. 2. As the setting of input span and polarity is 0~5V, the range of measurement will be 0~420°C. When the display value is greater than 450°C, it means the line broken of the thermocouple and the output indication "AO0" will be ON. 3. As the setting of input span and polarity is -10~10V, the range of measurement will be -200~750°C. When the display value is greater than 900°C, it means the line broken of the thermocouple and the output indication "AO0" will be ON. 4. As the setting of input span and polarity is -5~5V, the range of measurement will be -200~420°C. When the displayed temperature value is greater than 450°C, it means the line broken of the thermocouple and the output indication "AO0" will be ON. ● When the sensor is RTD type of PT-100 (it needs FB-2AH4) or PT-1000 (it needs FB-2AT4): <ol style="list-style-type: none"> 1. As the setting of input span is -10~10V, the range of measurement will be -49.8°C~146.6°C (DIN) or -50.7°C~149.2°C (JIS) 2. As the setting of input span is -10~10V, the range of measurement will be -12.3°C~83.6°C (DIN) or -12.5°C~85.1°C (JIS) 3. When the display value is greater than 900.0°C, it means the line broken of the sensor and the output indication "AO0" will be ON. <p>Note: When there exists the line broken of the sensor, it can be told from the content of WR+0 working register which tells the input point(s) of line broken.</p> <ul style="list-style-type: none"> ● Sm: Starting point of temperature measurement of this module. It must be the multiple of 4 , $0 \leq Sm \leq 28$. ● Ym: Starting address of discrete output of this module for multiplexing temperature input; it takes 8 points of discrete output. ● AR: Address of analog input (3rd) for temperature measurement of this module. ● TR: Starting register of the engineering value of temperature measurement, 4 registers in total. TR+0 stores the 1st temperature, ..., TR+3 stores the 4th temperature. ● PID operation will begin after FUN73 has measured the temperature of every point. ● When execution control "EN" = 1, it depends on the input status of H/C for PID operation to make heating (H/C=1) or cooling (H/C=0) control. The current values of measured temperature are through the multiplexing temperature module [FB-2AJ(K)4/FB-2AH(T)4] to get; the set points of desired temperature are stored in the registers starting from Sv. With the calculation of software PID expression, it will respond the error with an output signal according to the setting of setpoint, the error's integral and the rate of change of the process variable. Convert the output of PID calculation to be the time proportional on/off (PWM) output, and via transistor output to control the SSR for heating or cooling process; where there is a good performance and very low cost solution. It may also apply the output of PID calculation (stored in registers starting from OR), by way of D/A analog output module, to control SCR or proportional valve, so as to get more precise process control. ● When Sh, Zh setting error, this instruction will not be executed and the instruction output "ERR" will be ON. ● This instruction compares the current value with the set point to check whether the current temperature falls within deviation range (stored in register starting from Os). If it falls in the deviation range, it will set the in-zone bit of that point to be ON; if not, clear the in-zone bit of that point to be OFF, and make instruction output "AO1" ON. ● In the mean time, this instruction will also check whether highest temperature warning (the register for the set point of highest temperature warning is R4008). When successively scanning for ten times the current values of measured temperature are all higher than or equal to the highest warning set point, the warning bit will set to be ON and instruction output "AO1" will be on. This can avoid the safety problem aroused from temperature out of control, in case the SSR or heating circuit becomes short. ● This instruction can also detect the unable to heat problem resulting from the SSR or heating circuit runs open, or the obsolete heating band. When output of temperature control turns to be large power (set in R4006 register) successively in a certain time (set in R4007 register), and can not make current temperature fall in desired range, the warning bit will set to be ON and instruction output "AO1" will be ON. 		

Temperature instruction proper to FB-2AJ(K)4/ FB-2AH(T)4

FUN 73 TSTC	Convenient instruction of PID temperature control for FB-2AJ(K)4/FB-2AH(T)4	FUN 73 TSTC
<ul style="list-style-type: none"> ● Yh : Starting address of PID ON/OFF output; it takes Zh points ● Sh : Starting point of PID control of this instruction; where $0 \leq Sh \leq 31$. ● Zh : Number of the PID control of this instruction; where $1 \leq Zh \leq 32$ and $1 \leq Sh + Zh \leq 32$ ● Sv : Starting register of the setpoint; it takes Zh registers. ● Os : Starting register of the in-zone offset; it takes Zh registers. ● PR : Starting register of the gain (Kc); it takes Zh registers. ● IR : Starting register of integral tuning constant (Ti); it takes Zh registers ● DR : Starting register of derivative tuning constant (Td); it takes Zh registers. ● OR : Starting register of the PID analog output; it takes Zh registers. ● WR: Starting of working register for this instruction. It takes 17 registers and can't be repeated in using. The content of WR+0 register indicates the status of the sensor which is line broken or not. Bit definition of WR+0 explained as follows: Bit0=1 indicating that the Sm+0 point of sensor is line broken... Bit3=1 indicating that the Sm+3 point of sensor is line broken. The content of the two registers WR+8 and WR+9 indicating that whether the current temperature falls within the deviation range (stored in registers starting from Os). If it falls in the deviation range, the in-zone bit of that point will be set ON; if not, the in-zone bit of that point will be cleared OFF. Bit definition of WR+8 explained as follows: Bit0=1, it represents that the temperature of the Sh+0 point is in-zone... Bit15=1, it represents that the temperature of the Sh+15 point is in-zone. Bit definition of WR+9 explained as follows: Bit0=1, it represents that the temperature of the Sh+16 point is in-zone... Bit15=1, it represents that the temperature of 32th point is in-zone. The content of the two registers WR+10 and WR+11 are the warning bit registers, they indicate that whether there exists the highest temperature warning or heating circuit opened. Bit definition of WR+10 explained as follows: Bit0=1, it means that there exists the highest warning or heating circuit opened at the Sh+0 point... Bit15=1, it means that there exists the highest warning or heating circuit opened at the Sh+15 point. Bit definition of WR+11 explained as follows: Bit0=1, it means that there exists the highest warning or heating circuit opened at the Sh+16 point... Bit15=1, it means that there exists the highest warning or heating circuit opened at the 32th point. Registers of WR+2~WR+7 and WR+12~WR+16 are used by this instruction. <ul style="list-style-type: none"> ● This instruction can only be used to perform heating or cooling control of positive temperature while the sensor is the thermocouple. ● Whether the FUN73 is placed in main or sub program and no matter the execution control "EN"=0 or 1, this instruction must be executed at every scan. 		
<div style="border: 1px solid black; padding: 2px; margin-bottom: 5px;"> <p>Specific registers related to instruction of FUN73</p> </div> <ul style="list-style-type: none"> ● R4014 : Time interval between the measurement points while multiplexing. Which the user can set up. The unit is in mS and the default value is 500; it means it needs 500mS to measure one point of temperature. This means the update rate of the temperature is 2 seconds ($500mS \times 4 = 2000mS$) When the value of R4014 is 250, it means it needs 250mS to measure one point of temperature; the update rate of the temperature is 1 second ($250mS \times 4 = 1000mS$). When the value of R4014 is 1000, it means it needs 1000mS to measure one point of temperature; the update rate of the temperature is 4 second ($1000mS \times 4 = 4000mS$). When the value of R4014 is 2000, it means it needs 2000mS to measure one point of temperature; the update rate of the temperature is 4 second ($2000mS \times 4 = 8000mS$). 		

FUN 73 TSTC	Convenient instruction of PID temperature control for FB-2AJ(K)4/FB-2AH(T)4	FUN 73 TSTC
<ul style="list-style-type: none"> ● R4015 : Times for the average of measurement, which can be set by the user. <ul style="list-style-type: none"> =0, no average ; every acquired value is the measured value (default) =1, average of 2 times; the average on the acquired 2 times of values is the measured value. =2, average of 4 times; the average on the acquired 4 times of values is the measured value. =3, average of 8 times; the average on the acquired 8 times of values is the measured value. =4, average of 16 times; the average on the acquired 16 times of values is the measured value. ● R4016 : The factor for linear scaling to calculate the engineering value of K-type thermocouple while in positive temperature; the default value is 248. The expression for engineering value is as follows: <ul style="list-style-type: none"> Engineering unit temperature value = (Original temperature value ×R4016) /1024 (Unipolar). Engineering unit temperature value = (Original temperature value ×2×R4016) /1024 (Bipolar). <p>When there is a slight difference in measurement result between the standard meter and the FB-PLC's temperature module, if the user would like to use the value acquired by standard meter for correction, the user can tune the value of R4016 to get a better result in temperature measurement. This register provides fine tuning for positive temperature.</p> ● R4017 : The factor for linear scaling to calculate the engineering value of K-type thermocouple while in negative temperature; the default value is 286. The expression for engineering value is as follows: <ul style="list-style-type: none"> Engineering value = (Primitive temperature value ×R4017) /1024 (-5~5V). Engineering value = (Primitive temperature value ×2×R4017) /1024 (-10~10V). <p>When there is a slight difference in measurement result between the standard meter and the FB-PLC's temperature module, if the user would like to use the value acquired by standard meter for correction, the user can tune the value of R4017 to get a better result in temperature measurement. This register provides fine tuning for negative temperature.</p> ● R4018 : The factor for linear scaling to calculate the engineering value of J-type thermocouple while in positive temperature; the default value is 240. <ul style="list-style-type: none"> The expression for engineering value is as follows: Engineering value = (Primitive temperature value ×R4018) /1024 (Unipolar). Engineering value = (Primitive temperature value ×2×R4018) /1024 (Bipolar). <p>When there is a slight difference in measurement result between the standard meter and the FB-PLC's temperature module, if the user would like to use the value acquired by standard meter for correction, the user can tune the value of R4018 to get a better result in temperature measurement. This register provides fine tuning for positive temperature.</p> ● R4019 : The factor for linear scaling to calculate the engineering value of J-type thermocouple while in negative temperature; the default value is 280. <ul style="list-style-type: none"> The expression for engineering value is as follows: Engineering value = (Primitive temperature value ×R4019) /1024 (-5~5V). Engineering value = (Primitive temperature value ×2×R4019) /1024 (-10~10V). <p>When there is a slight difference in measurement result between the standard meter and the FB-PLC's temperature module, if the user would like to use the value acquired by standard meter for correction, the user can tune the value of R4019 to get a better result in temperature measurement. This register provides fine tuning for negative temperature.</p> ● R4020 : High Byte of R4020 to tell the alpha value of RTD, =0, $\alpha=0.00385$ (DIN) =1, $\alpha=0.00392$ (JIS) <ul style="list-style-type: none"> : Low Byte of R4020 to tell where the registers storing the wire resistance for compensation, =1, the wire resistance for compensation for 3-wires RTD input storing in registers Rxxxx =2, the wire resistance for compensation for 3-wires RTD input storing in registers Dxxxx The starting address of above mentioned registers is storing in R4021 . The default of R4020 is 0001H. ● R4021: Storing the starting address of the registers to store the wire resistance for compensation for 3-wires RTD input; the default of R4021 is 8000, it means the starting register to store the wire resistance for compensation is R8000 by default. The unit of the resistance is 0.1Ω. While in long distance measurement and the accuracy will be affected by the wire resistance of the connection between the RTD sensor and temperature module, under such situation, the user has to measure the wire resistance of each loop and input them to the registers mentioned above; otherwise, forget these. ● R4022 : The factor for linear scaling to calculate the engineering value of PT-100 ; the default value is 1024 <ul style="list-style-type: none"> The expression for engineering value is as follows: Engineering value = (Primitive temperature value ×R4022) /1024 ● R4023 : The factor for linear scaling to calculate the engineering value of PT-1000 ; the default is 1024 <ul style="list-style-type: none"> The expression for engineering value is as follows: Engineering value = (Primitive temperature value ×R4023) /1024 <p>When it needs to do the calibration between the standard meter and the FB-PLC's temperature module, the user can tune the value of R4022 or R4023 to get a better result of measurement.</p> 		

Temperature instruction proper to FB-2AJ(K)4/ FB-2AH(T)4

FUN 73 TSTC	Convenient instruction of PID temperature control for FB-2AJ(K)4/FB-2AH(T)4	FUN 73 TSTC
<ul style="list-style-type: none"> ● R4010 : Each bit of R4010Bit15=1 means that to tell the status of the sensor's installation. Bit0=1 means that 1st point of temperature sensor is installed. Bit1=1 means that 2nd point of temperature sensor is installed. . . . Bit15=1 means that 16th point of temperature sensor is installed. (The default of R4010 is FFFFH) ● R4011: R4011 : Each bit of R4011 to tell the status of the sensor's installation. Bit0=1 means that 17th point of temperature sensor is installed. Bit1=1 means that 18th point of temperature sensor is installed. . . . Bit15=1 means that 32nd point of temperature sensor is installed. (The default of R4011 is FFFFH) ● When the temperature sensor is installed (the corresponding bit of R4010 or R4011 must be 1), the system will perform the line broken detection to the sensor. If there is line broken happened to the sensor, there will have the warning and the line broken value will be displayed. ● When the temperature sensor is not installed (the corresponding bit of R4010 or R4011 must be 0), the system won't perform the line broken detection to the sensor and there will not have the warning; the temperature value will be displayed as 0. ● Depends on the sensor's installation , the ladder program may control the corresponding bit of R4010 and R4011 to perform or not to perform the line broken detection. ● R4005 : The content of Low Byte to define the solution interval between PID calculation =0, perform the PID calculation every 2 seconds (System default). =1, perform the PID calculation every 4 seconds. =2, perform the PID calculation every 8 seconds. ≥3, perform the PID calculation every 1 second. (R4014 must be 250 to make sense) : The content of High Byte to define the cycle time of PID ON/OFF (PWM) output. =0 , PWM cycle time is 2 seconds (system default) =1 , PWM cycle time is 4 seconds. =2 , PWM cycle time is 8 seconds. ≥3 , PWM cycle time is 1 second. <p>Note 1 : When changing the value of R4005, the execution control "EN" of FUN73 must be set at 0. The next time when execution control "EN" =1, it will base on the latest set point to perform the PID calculation.</p> <p>Note 2 : The smaller the cycle time of PWM, the more even can it perform the heating. However, the error caused by the PLC scan time will also become greater. For the best control, it can base on the scan time of PLC to adjust the solution interval of PID calculation and the PWM cycle time.</p> <ul style="list-style-type: none"> ● R4006 : The setting point of large power output detection for SSR or heating circuit opened, or heating band obsolete. The unit is in % and the setting range falls in 80~100(%); system default is 90(%). ● R4007 : The setting time to detect the continuing duration of large power output while SSR or heating circuit opened, or heating band obsolete. The unit is in second and the setting range falls in 300~65535 (seconds); system default is 600 (seconds). ● R4008 : The setting point of highest temperature warning for SSR, or heating circuit short detection. The unit is in degree and the setting range falls in 50~65535; system default is 350 (degrees). ● R4012 : Each bit of R4012 to tell the need of PID temperature control. Bit0=1 means that 1st point needs PID temperature control. Bit1=1 means that 2nd point needs PID temperature control. . . . 16th point needs PID temperature control. (The default of R4012 is FFFFH) ● R4013 : Each bit of R4013 to tell the need of PID temperature control. Bit0=1 means that 17th point needs PID temperature control. Bit1=1 means that 18th point needs PID temperature control. . . . Bit15=1 means that 32nd point needs PID temperature control. (The default of R4013 is FFFFH) ● While execution control "EN"=1 and the corresponding bit of PID control of that point is ON (corresponding bit of R4012 or R4013 must be 1), the FUN73 instruction will perform the PID operation and respond to the calculation with the output signal. ● While execution control "EN"=1 and the corresponding bit of PID control of that point is OFF (corresponding bit of R4012 or R4013 must be 0), the FUN73 will not perform the PID operation and the output of that point will be OFF. ● The ladder program may control the corresponding bit of R4012 and R4013 to tell the FUN73 to perform or not to perform the PID control, and it needs only one FUN73 instruction. (The temperature module must be identical in sensor type and the setting of input span and polarity must be the same.) 		

FUN 73 TSTC	Convenient instruction of PID temperature control for FB-2AJ(K)4/FB-2AH(T)4	FUN 73 TSTC
----------------	---	----------------

Program example 1 The main unit is FBx-40MC(A) ,and 4 temperature modules of FB-2AK4 are attached.
The settings of input span and polarity are all at 0~10V.

- *** It takes only one FUN73 instruction to perform 16 points of PID temperature control when the temperature modules are identical in sensor type and the settings of input span and polarity are the same.
- *** When performing the FUN73 instruction of the first time, the system will automatically assign to each point its system default of gain (Kc), integral tuning constant (Ti), and derivative tuning constant (Td), etc. The user may change the settings if necessary.

	<ul style="list-style-type: none"> ● The status of M800~M831 are controlled by the MMI or external inputs to tell the status of sensor's installation; if it has the sensor, perform line broken detection, and not to perform the check if it hasn't. (It needs the retentive function, so M800~M1399 are the better choice). ● When temperature sensor installed (the corresponding bit of R4010 or R4011 is 1) and there is line broken of the sensor, the line broken value of that point will be displayed. ● When temperature sensor is not installed (the corresponding bit of R4010 or R4011 is 0), there will not perform the line broken detection; the temperature of that point is displayed 0. 	<table border="0"> <tr><td colspan="2">08D.MOV</td></tr> <tr><td>S :</td><td>WM 800</td></tr> <tr><td>D :</td><td>R 4010</td></tr> </table>	08D.MOV		S :	WM 800	D :	R 4010												
08D.MOV																				
S :	WM 800																			
D :	R 4010																			
	<ul style="list-style-type: none"> ● The status of M832~M863 are controlled by the MMI or external inputs to tell whether it needs the PID control of the corresponding point; perform the PID operation when the bit is ON, and not to perform if it is OFF (It needs the retentive function, so M800~M1399 are the better choice). ● When temperature control bit is ON (the corresponding bit of R4012 or R4013 is 1), FUN73 performs the PID operation of that point to obtain a suitable output signal. ● When temperature control bit is OFF (the corresponding bit of R4012 or R4013 is 0), FUN73 will not perform the PID operation of that point and output will be OFF. 	<table border="0"> <tr><td colspan="2">08D.MOV</td></tr> <tr><td>S :</td><td>WM 832</td></tr> <tr><td>D :</td><td>R 4012</td></tr> </table>	08D.MOV		S :	WM 832	D :	R 4012												
08D.MOV																				
S :	WM 832																			
D :	R 4012																			
M3	<ul style="list-style-type: none"> ● When M3=ON, to measure the temperature of 13th (Sm=12) ~ 16th point of K-type thermocouple inputs and store the engineering values of measurement into R12~R15; also, store the primitive values into R3980~R3983. ● When there is line broken of the sensor, the value of line broken will be displayed. 	<table border="0"> <tr><td colspan="2">72.TP4</td></tr> <tr><td>Tp :</td><td>0</td><td rowspan="2">-ERR-</td></tr> <tr><td>Pl :</td><td>0</td></tr> <tr><td>Sm :</td><td>12</td><td>-ALM-</td></tr> <tr><td>Ym: Y</td><td>40</td></tr> <tr><td>AR: R</td><td>3851</td></tr> <tr><td>TR: R</td><td>12</td></tr> <tr><td>WR: R</td><td>240</td></tr> </table>	72.TP4		Tp :	0	-ERR-	Pl :	0	Sm :	12	-ALM-	Ym: Y	40	AR: R	3851	TR: R	12	WR: R	240
72.TP4																				
Tp :	0	-ERR-																		
Pl :	0																			
Sm :	12	-ALM-																		
Ym: Y	40																			
AR: R	3851																			
TR: R	12																			
WR: R	240																			
M3	<ul style="list-style-type: none"> ● When M3=ON, to measure the temperature of 9th (Sm=8) ~ 12th point of K-type thermocouple inputs and store the engineering values of measurement into R8~R11; also, store the primitive values into R3976~R3979. ● When there is line broken of the sensor, the value of line broken will be displayed. 	<table border="0"> <tr><td colspan="2">72.TP4</td></tr> <tr><td>Tp :</td><td>0</td><td rowspan="2">-ERR-</td></tr> <tr><td>Pl :</td><td>0</td></tr> <tr><td>Sm :</td><td>8</td><td>-ALM-</td></tr> <tr><td>Ym: Y</td><td>32</td></tr> <tr><td>AR: R</td><td>3848</td></tr> <tr><td>TR: R</td><td>8</td></tr> <tr><td>WR: R</td><td>230</td></tr> </table>	72.TP4		Tp :	0	-ERR-	Pl :	0	Sm :	8	-ALM-	Ym: Y	32	AR: R	3848	TR: R	8	WR: R	230
72.TP4																				
Tp :	0	-ERR-																		
Pl :	0																			
Sm :	8	-ALM-																		
Ym: Y	32																			
AR: R	3848																			
TR: R	8																			
WR: R	230																			
M3	<ul style="list-style-type: none"> ● When M3=ON, to measure the temperature of 5th (Sm=4) ~ 8th point of K-type thermocouple inputs and store the engineering values of measurement into R4~R7; also, store the primitive values into R3972~R3975. ● When there is line broken of the sensor, the value of line broken will be displayed. 	<table border="0"> <tr><td colspan="2">72.TP4</td></tr> <tr><td>Tp :</td><td>0</td><td rowspan="2">-ERR-</td></tr> <tr><td>Pl :</td><td>0</td></tr> <tr><td>Sm :</td><td>4</td><td>-ALM-</td></tr> <tr><td>Ym: Y</td><td>24</td></tr> <tr><td>AR: R</td><td>3845</td></tr> <tr><td>TR: R</td><td>4</td></tr> <tr><td>WR: R</td><td>220</td></tr> </table>	72.TP4		Tp :	0	-ERR-	Pl :	0	Sm :	4	-ALM-	Ym: Y	24	AR: R	3845	TR: R	4	WR: R	220
72.TP4																				
Tp :	0	-ERR-																		
Pl :	0																			
Sm :	4	-ALM-																		
Ym: Y	24																			
AR: R	3845																			
TR: R	4																			
WR: R	220																			

Temperature instruction proper to FB-2AJ(K)4/ FB-2AH(T)4

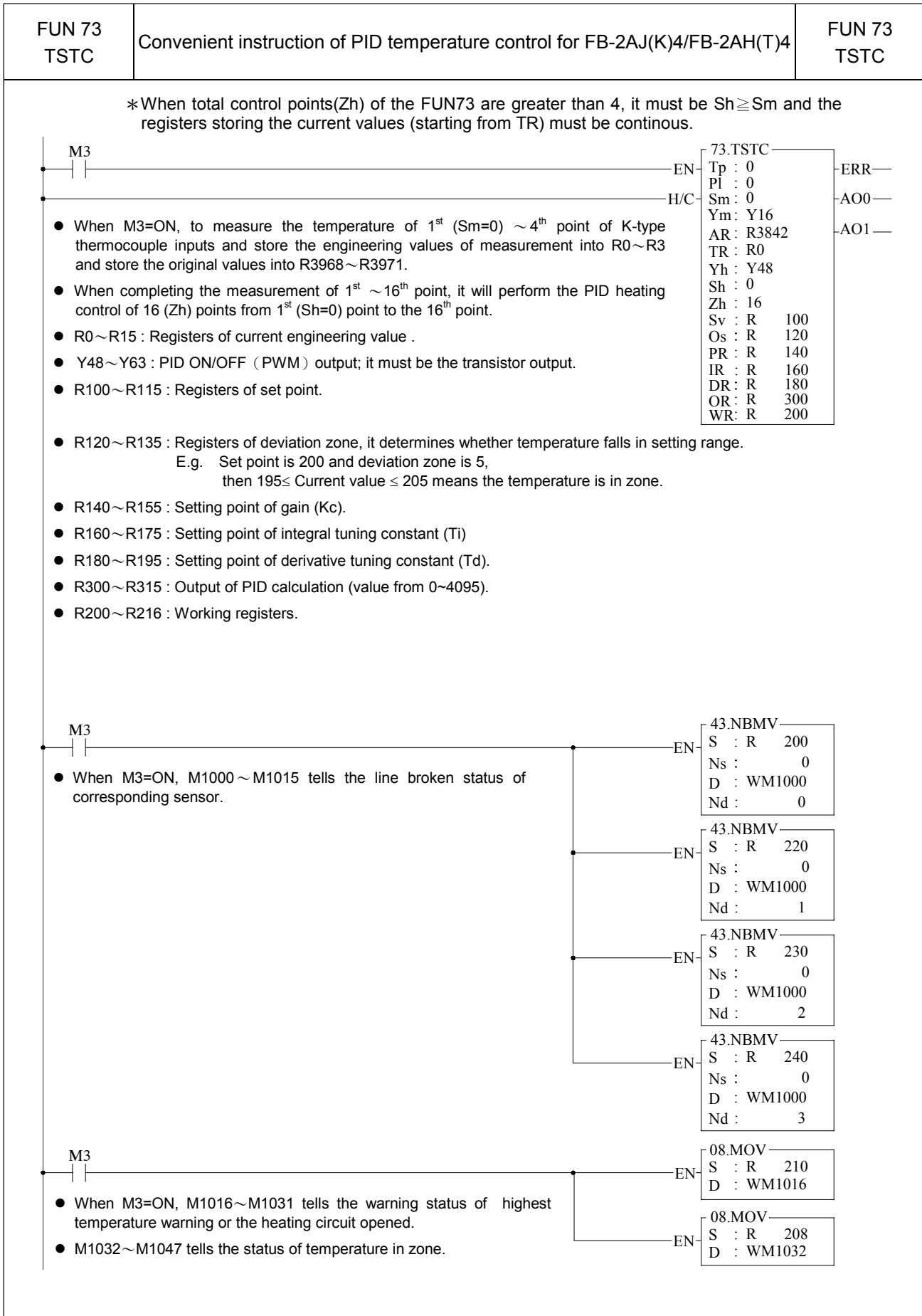

FUN 73 TSTC	Convenient instruction of PID temperature control for FB-2AJ(K)4/FB-2AH(T)4	FUN 73 TSTC																
<p>Program example 2 The main unit is FBx-40MC(A) ,and 4 temperature modules of FB-2AH4 are attached. The settings of input span are all at 5V (the polarity are fixed at bipolar).</p>																		
<p>*** It takes only one FUN73 instruction to perform 16 points of PID temperature control when the temperature modules are identical in sensor type and the settings of input span and polarity are the same.</p> <p>*** When performing the FUN73 instruction of the first time, the system will automatically assign to each point its system default of gain (Kc), integral tuning constant (Ti), and derivative tuning constant (Td), etc. The user may change the settings if necessary.</p>																		
<ul style="list-style-type: none"> ● The status of M800~M831 are controlled by the MMI or external inputs to tell the status of sensor's installation; if it has the sensor, perform line broken detection, and not to perform the check if it hasn't. (It needs the retentive function, so M800~M1399 are the better choice). ● When temperature sensor installed (the corresponding bit of R4010 or R4011 is 1) and there is line broken of the sensor, the line broken value of that point will be displayed. ● When temperature sensor is not installed (the corresponding bit of R4010 or R4011 is 0), there will not perform the line broken detection; the temperature of that point is displayed 0. 	<p>EN</p>	<table border="1"> <tr><td colspan="2">08D.MOV</td></tr> <tr><td>S</td><td>: WM 800</td></tr> <tr><td>D</td><td>: R 4010</td></tr> </table>	08D.MOV		S	: WM 800	D	: R 4010										
08D.MOV																		
S	: WM 800																	
D	: R 4010																	
<ul style="list-style-type: none"> ● The status of M832~M863 are controlled by the MMI or external inputs to tell whether it needs the PID control of the corresponding point; perform the PID operation when the bit is ON, and not to perform if it is OFF (It needs the retentive function, so M800~M1399 are the better choice). ● When temperature control bit is ON (the corresponding bit of R4012 or R4013 is 1), FUN73 performs the PID operation of that point to obtain a suitable output signal. ● When temperature control bit is OFF (the corresponding bit of R4012 or R4013 is 0), FUN73 will not perform the PID operation of that point and output will be OFF. 	<p>EN</p>	<table border="1"> <tr><td colspan="2">08D.MOV</td></tr> <tr><td>S</td><td>: WM 832</td></tr> <tr><td>D</td><td>: R 4012</td></tr> </table>	08D.MOV		S	: WM 832	D	: R 4012										
08D.MOV																		
S	: WM 832																	
D	: R 4012																	
<p>M3</p> <ul style="list-style-type: none"> ● When M3=ON, to measure the temperature of 13th (Sm=12) ~16th point of PT-100 RTD inputs and store the engineering values of measurement into R12 ~R15; also, store the primitive values into R3980~R3983. ● When there is line broken of the sensor, the value of line broken will be displayed. 	<p>EN</p>	<table border="1"> <tr><td colspan="2">72.TP4</td></tr> <tr><td>Tp</td><td>: 2</td></tr> <tr><td>PI</td><td>: 3</td></tr> <tr><td>Sm</td><td>: 12</td></tr> <tr><td>Ym: Y</td><td>40</td></tr> <tr><td>AR: R</td><td>3851</td></tr> <tr><td>TR: R</td><td>12</td></tr> <tr><td>WR: R</td><td>240</td></tr> </table> <p>ERR—</p> <p>ALM—</p>	72.TP4		Tp	: 2	PI	: 3	Sm	: 12	Ym: Y	40	AR: R	3851	TR: R	12	WR: R	240
72.TP4																		
Tp	: 2																	
PI	: 3																	
Sm	: 12																	
Ym: Y	40																	
AR: R	3851																	
TR: R	12																	
WR: R	240																	
<p>M3</p> <ul style="list-style-type: none"> ● When M3=ON, to measure the temperature of 9th (Sm=8) ~12th point of PT-100 RTD inputs and store the engineering values of measurement into R8~R11; also, store the primitive values into R3976~R3979. ● When there is line broken of the sensor, the value of line broken will be displayed. 	<p>EN</p>	<table border="1"> <tr><td colspan="2">72.TP4</td></tr> <tr><td>Tp</td><td>: 2</td></tr> <tr><td>PI</td><td>: 3</td></tr> <tr><td>Sm</td><td>: 8</td></tr> <tr><td>Ym: Y</td><td>32</td></tr> <tr><td>AR: R</td><td>3848</td></tr> <tr><td>TR: R</td><td>8</td></tr> <tr><td>WR: R</td><td>230</td></tr> </table> <p>ERR—</p> <p>ALM—</p>	72.TP4		Tp	: 2	PI	: 3	Sm	: 8	Ym: Y	32	AR: R	3848	TR: R	8	WR: R	230
72.TP4																		
Tp	: 2																	
PI	: 3																	
Sm	: 8																	
Ym: Y	32																	
AR: R	3848																	
TR: R	8																	
WR: R	230																	
<p>M3</p> <ul style="list-style-type: none"> ● When M3=ON, to measure the temperature of 5th (Sm=4) ~8th point of PT-100 RTD inputs and store the engineering values of measurement into R4~R7; also, store the primitive values into R3972~R3975. ● When there is line broken of the sensor, the value of line broken will be displayed. 	<p>EN</p>	<table border="1"> <tr><td colspan="2">72.TP4</td></tr> <tr><td>Tp</td><td>: 2</td></tr> <tr><td>PI</td><td>: 3</td></tr> <tr><td>Sm</td><td>: 4</td></tr> <tr><td>Ym: Y</td><td>24</td></tr> <tr><td>AR: R</td><td>3845</td></tr> <tr><td>TR: R</td><td>4</td></tr> <tr><td>WR: R</td><td>220</td></tr> </table> <p>ERR—</p> <p>ALM—</p>	72.TP4		Tp	: 2	PI	: 3	Sm	: 4	Ym: Y	24	AR: R	3845	TR: R	4	WR: R	220
72.TP4																		
Tp	: 2																	
PI	: 3																	
Sm	: 4																	
Ym: Y	24																	
AR: R	3845																	
TR: R	4																	
WR: R	220																	

Temperature instruction proper to FB-2AJ(K)4/ FB-2AH(T)4

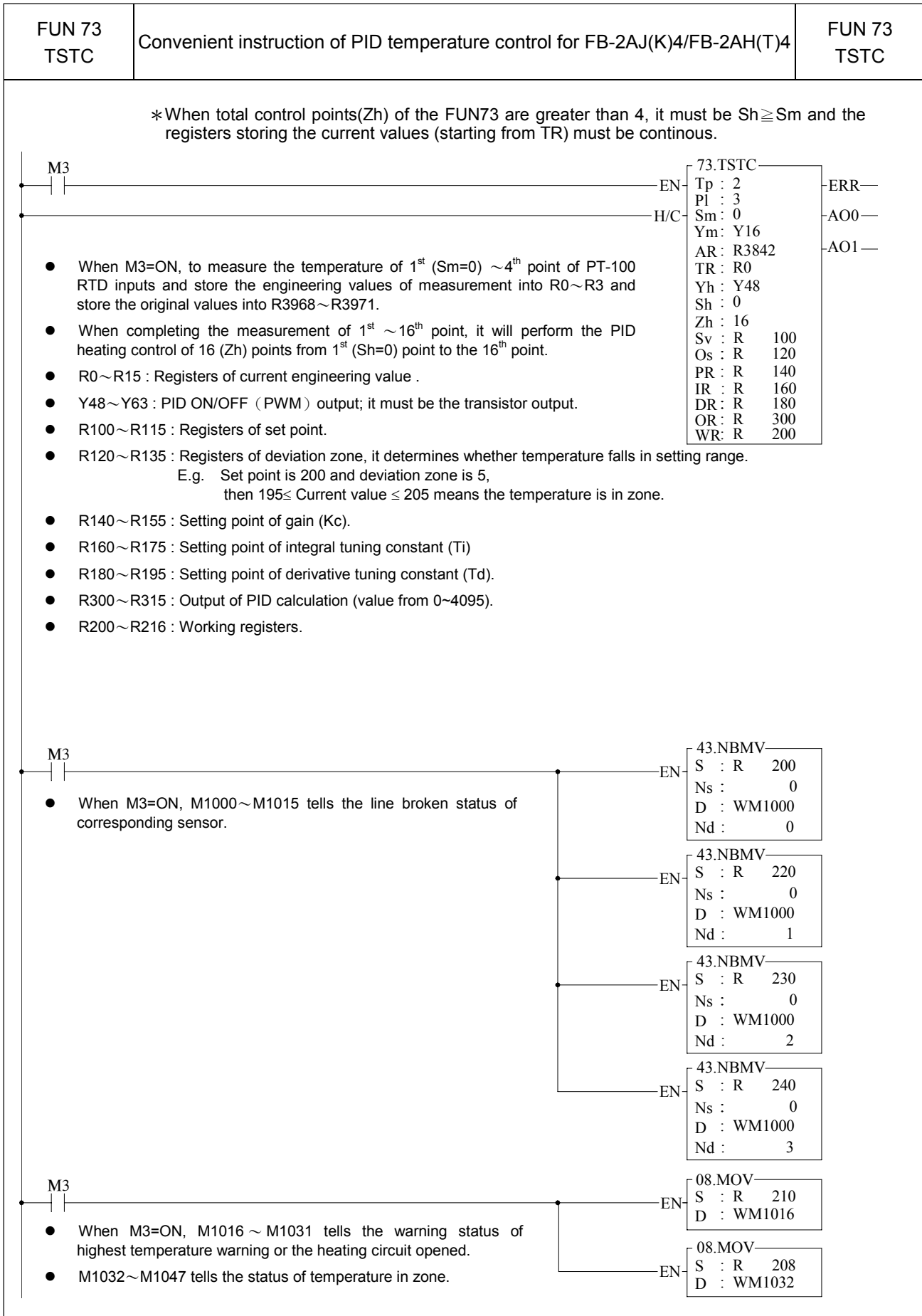

FUN 85 TPSNS	Convenient instruction proper to FB-4AJ(K)xx temperature module	FUN 85 TPSNS
-----------------	---	-----------------

Execution control -EN

85.TPSNS	
Tp :	-ERR-Parameter error
Pl :	-ALM-Sensor line broken
Zn :	
Yn :	
SR :	
WR :	

Tp: Type of sensor;
 =0, K-type thermocouple
 =1, J-type thermocouple
 P1 : Setting of polarity and span;
 =0, 0~10V (Unipolar)
 =1, 0~5V (Unipolar)
 =2, -10~10V (Bipolar)
 =3, -5~5V (Bipolar)
 Unipolar: U/B jumper set at U
 Bipolar: U/B jumper set at B
 Span : 5V/10V jumper setting
 Zn : Setting of input points for temperature;
 = 12, 18, 24
 Yn : Starting address of discrete output of this module for multiplexing temperature input; it takes 8 points. When expansion module with discrete output will be installed after the temperature module, the discrete output address of which must be added 8.
 SR : Starting register of the engineering value of temperature measurement; it takes Zn registers.
 WR : Starting of working register for this instruction. It takes 5 registers and can't be repeated in using.

Range	Y	HR	ROR	DR	K
Operand	Y0	R0	R5000	D0	
	Y255	R3839	R8071	D3071	
Tp					0~1
Pl					0~3
Zn					12, 18, 24
Yn	○				
SR		○	○*	○	
WR		○	○*	○	

Note 1: FUN85 is the Convenient instruction dedicated for the multiplexing temperature modules: FB-4AJ(K)xx; where xx may be 12,18,24 ; it means the temperature inputs.
 Note 2: The FB-4AJ(K)xx temperature module can only be installed alone, it can't work together with FB-8AD, FB-2AJ(K)4,FB-2AH(T)4 or FB-6AD modules.

Function guide and notifications

FB-4AJ(K)xx multiplexing temperature module occupies 8 points of analog input address and 8 points of discrete output address in physical, more detail as followings:

- FB-4AJxx (where, xx may be 12,18,24) provides 4 points of general purpose analog inputs (1st ~ 4th analog input) and xx points of J-type thermocouple inputs for temperature measurement (With the combination of 5th ~ 8th analog inputs and 8 points of discrete output making upto 24 points of temperature measurement).
- FB-4AKxx (where, xx may be 12,18,24) provides 4 points of general purpose analog inputs (1st ~ 4th analog input) and xx points of K-type thermocouple inputs for temperature measurement (With the combination of 5th ~ 8th analog inputs and 8 points of discrete output making upto 24 points of temperature measurement)
- The selection of input span of FB-4AJ(K)xx temperature module can be 5V (500°C) or 10V (1000°C); the input polarity can be set as unipolar (U/B jumper setting at U) or bipolar (U/B jumper setting at B):
 - When setting at 10V(1000°C) and unipolar,
the range of measurement is 0°C~750°C (J-type) or 0°C~900°C (K-type)
 - When setting at 5V(500°C) and unipolar,
the range of measurement is 0°C~420°C (J-type) or 0°C~450°C (K-type)
 - When setting at 10V(1000°C) and bipolar,
the range of measurement is -200°C~750°C (J-type) or -200°C~900°C(K-type)
 - When setting at 5V(500°C) and bipolar,
the range of measurement is -200°C~420°C (J-type) or -200°C~450°C(K-type)
- FB-4AJ(K)xx multiplexing temperature module occupies 8 points of analog input address and 8 points of discrete output address in physical;
 - This kind of temperature module can only be installed alone, it can't work together with FB-8AD, FB-6AD, FB-2AJ(K)4,FB-2AH(T)4 or FB-4A(JK)xx modules.
 - when expansion module with discrete output will be installed after this kind of module, the discrete output address of which must be added 8.
- The memory mapping of general purpose analog inputs as follows:
 Address of 1st analog input is R3840; Address of 2nd analog input is R3841
 Address of 3rd analog input is R3842; Address of 4th analog input is R3843
- If the setting of input polarity is unipolar, the primitive value of general purpose analog input is -2048~2047, so, it may be added with the offset 2048 to convert it to be the range of 0~4095 for later operation.
- For the selection of thermocouple, K-type thermocouple is recommended.
- It is recommended to select 0~5V for the span and polarity of input if it meets the requirement.
- Connect the "FG" terminal with the shielding of thermocouple if it is with for better measurement.
- The "G⊕" terminal must be connected to the safty earth ground of the power system.

Measuring instruction proper to FB-4AJ(K)xx temperature module

FUN 85 TPSNS	Convenient instruction proper to FB-4AJ(K)xx temperature module	FUN 85 TPSNS
<div data-bbox="209 331 762 362" style="border: 1px solid black; padding: 2px;"> <p>User guide for convenient instruction FUN85</p> </div> <ul style="list-style-type: none"> ● When execution control “EN”=1, this instruction will perform multiplexing temperature measurement and store the primitive value into R3968 (TP0) …R3991 (TP23) ; the value falls in 0~4095 (unipolar) or -2048 ~2047 (bipolar). And then base on the setting of temperature sensor (Tp), input span and polarity (PI) of the temperature module to scale the primitive values to engineering values and store them into temperature measurement registers (SR+0 as the 1st point, …, SR+23 as the 24th point) ● When the setting of Tp · PI · Zn comes error, this instruction will not be performed and the output indication “ERR” will be ON. ● When the sensor is K-type thermocouple (it needs FB-4AKxx module): <ol style="list-style-type: none"> 1. As the setting of input span and polarity is 0~10V, the range of measurement will be 0~900°C. When the display value is greater than 900°C, it means the line broken of the thermocouple and the output indication “ALM” will be ON. 2. As the setting of input span and polarity is 0~5V, the range of measurement will be 0~450°C. When the display value is greater than 450°C, it means the line broken of the thermocouple and the output indication “ALM” will be ON. 3. As the setting of input span and polarity is -10~10V, the range of measurement will be -200~900°C. When the display value is greater than 900°C, it means the line broken of the thermocouple and the output indication “ALM” will be ON. 4. As the setting of input span and polarity is -5~5V, the range of measurement will be -200~450°C. When the display value is greater than 450°C, it means the line broken of the thermocouple and the output indication “ALM” will be ON.. ● When the sensor is J-type thermocouple (it needs FB-4AJxx module): <ol style="list-style-type: none"> 1.As the setting of input span and polarity is 0~10V, the range of measurement will be 0~750°C. When the display value is greater than 900°C, it means the line broken of the thermocouple and the output indication “ALM” will be ON. 2.As the setting of input span and polarity is 0~5V, the range of measurement will be 0~420°C. When the display value is greater than 450°C, it means the line broken of the thermocouple and the output indication “ALM” will be ON. 3.As the setting of input span and polarity is -10~10V, the range of measurement will be -200~750°C. When the display value is greater than 900°C, it means the line broken of the thermocouple and the output indication “ALM” will be ON. 4.As the setting of input span and polarity is -5~5V, the range of measurement will be -200~420°C. When the displayed temperature value is greater than 450°C, it means the line broken of the thermocouple and the output indication “ALM” will be ON. ● SR : Starting register of the engineering value of temperature measurement; it needs Zn registers in total. SR+0 stores the 1st point of temperature value, SR+1 stores the 2nd point of temperature value.... ● WR : Starting of working register for this instruction. It takes 5 registers and can't be repeated in using. The content of register WR+0 and WR+1 indicates the status of the sensor which is line broken or not. Bit definition of WR+0 explained as follows: <ul style="list-style-type: none"> Bit0 =1 indicating that the 1st point of sensor is line broken; ... Bit15=1 indicating that the 16th point of sensor is line broken. Bit definition of WR+1 explained as follows: <ul style="list-style-type: none"> Bit0 =1 indicating that the 17th point of sensor is line broken; ... Bit7=1 indicating that the 24th point of sensor is line broken. Registers WR+2~WR+7 are used by this instruction. ● FUN85 can only be used once. ● No matter the FUN85 is placed in main program or in sub-program, and whether the execution control “EN”=0 or 1, this instruction must be executed every scan. 		

FUN 85 TPSNS	Convenient instruction proper to FB-4AJ(K)xx temperature module	FUN 85 TPSNS
<div style="border: 1px solid black; padding: 5px; margin-bottom: 10px;"> <p>Specific registers for FUN85</p> </div> <ul style="list-style-type: none"> ● R3968~R3991: Registers storing the primitive temperature value. R3968 storing the 1st point, R3969 storing the 2nd point, etc. and R3991 storing the 24th point. The value is from 0~4095 (unipolar) or -2048~2047 (bipolar). ● R4000 : Low Byte of R4000 is generated from the system; FUN85 instruction will base on the setting of "temperature sensor (TP)" and "input span and polarity (PI)" to create the default and write it into the low byte of R4000. It is used to determine whether R4000~R4004 needs to be initialized; It is not allowed to change the low byte of R4000 by the user. <ul style="list-style-type: none"> : High Byte of R4000 to tell the times for the average of measurement, which can be set by the user. <ul style="list-style-type: none"> =0, no average; every acquired value is the measured value (default) =1, average of 2 times; the average on the acquired 2 times of values is the measured value. =2, average of 4 times; the average on the acquired 4 times of values is the measured value. =3, average of 8 times; the average on the acquired 8 times of values is the measured value. =4, average of 16 times; the average on the acquired 16 times of values is the measured value. ● R4001 : The factor for linear scaling to calculate the engineering value of K-type thermocouple while in positive temperature; <ul style="list-style-type: none"> when the setting of input span and polarity for K-type thermocouple is 0~10V or -10~10V, the default value is 248. when the setting of input span and polarity for K-type thermocouple is 0~5V or -5~5V, the default value is 124. when the setting of input span and polarity for J-type thermocouple is 0~10V or -10~10V, the default value is 240. when the setting of input span and polarity for J-type thermocouple is 0~5V or -5~5V, the default value is 120. <p style="padding-left: 20px;">The expression for engineering value is as follows:</p> <p style="padding-left: 40px;">Engineering value = (Primitive temperature value ×R4001) /1024 (Unipolar).</p> <p style="padding-left: 40px;">Engineering value = (Primitive temperature value ×2×R4001) /1024 (Bipolar).</p> <p>When there is a slight difference in measurement result between the standard meter and the FB-PLC's temperature module, if the user would like to use the value acquired by standard meter for correction, the user can tune the value of R4001 to get a better result in temperature measurement. This register provides fine tuning for positive temperature.</p> ● R4002 : The factor for linear scaling to calculate the engineering value of K-type thermocouple while in negative temperature; <ul style="list-style-type: none"> when the setting of input span and polarity for K-type thermocouple is -10~10V or -5~5V, the default value is 286. when the setting of input span and polarity for J-type thermocouple is -10~10V or -5~5V, the default value is 280. <p style="padding-left: 20px;">The expression for engineering value is as follows:</p> <p style="padding-left: 40px;">Engineering value = (Primitive temperature value ×R4002) /1024 (-5~5V).</p> <p style="padding-left: 40px;">Engineering value = (Primitive temperature value ×2×R4002) /1024 (-10~10V).</p> <p>When there is a slight difference in measurement result between the standard meter and the FB-PLC's temperature module, if the user would like to use the value acquired by standard meter for correction, the user can tune the value of R4002 to get a better result in temperature measurement. This register provides fine tuning for negative temperature.</p> ● R4003 : The setting value for line broken detection of thermocouple; <ul style="list-style-type: none"> when the setting of input span and polarity is 0~10V or -10~10V, the default value is 901. when the setting of input span and polarity is 0~5V or -5~5V, the default value is 451. 		

Measuring instruction proper to FB-4AJ(K)xx temperature module

FUN 85 TPSNS	Convenient instruction proper to FB-4AJ(K)xx temperature module	FUN 85 TPSNS
-----------------	---	-----------------

- R4004 :Time interval between the measurement points while multiplexing. Which the user can set up. The unit is in mS and the default value is 333, it means it needs 333mS to measure one point of temperature. This means the update rate of the temperature is 2 seconds (333mS×6=1998mS)
 When the value of R4004 is 166,
 it means it needs 166mS to measure one point of temperature.
 The update rate of the temperature is 1 second (166mS×6=996mS)
 When the value of R4014 is 666,
 it means it needs 666mS to measure one point of temperature.
 The update rate of the temperature is 4 seconds (666mS×6=3996mS)
 When the value of R4014 is 1333,
 it means it needs 1333mS to measure one point of temperature.
 The update rate of the temperature is 8 seconds (1333mS×4=7998mS)
- R4010 : Each bit of R4010 to tell the status of the sensor's installation.
 Bit0=1 means that 1st point of temperature sensor is installed.
 .
 .
 Bit15=1 means that 16th point of temperature sensor is installed.
 (The default of R4010 is FFFFH)
- R4011 : Each bit of R4011 to tell the status of the sensor's installation.
 Bit0=1 means that 17th point of temperature sensor is installed.
 .
 .
 Bit7=1 means that 24th point of temperature sensor is installed.
 (The default of R4011 is FFFFH)
- When the temperature sensor is installed (the corresponding bit of R4010 or R4011 must be 1), the system will perform the line broken detection to the sensor. If there is line broken happened to the sensor, there will have the warning and the line broken value will be displayed.
- When the temperature sensor is not installed (the corresponding bit of R4010 or R4011 must be 0), the system won't perform the line broken detection to the sensor and there will not have the warning; the temperature value will be displayed as 0.
- Depends on the sensor's installation, the ladder program may control the corresponding bit of R4010 and R4011 to tell FUN85 to perform or not to perform the line broken detection.

Program example

In following examples, the main unit is FBx-28MC(A), and the FB-4AK24 temperature module is attached ; the setting of the input span and polarity is 0~10V.

Program example 1

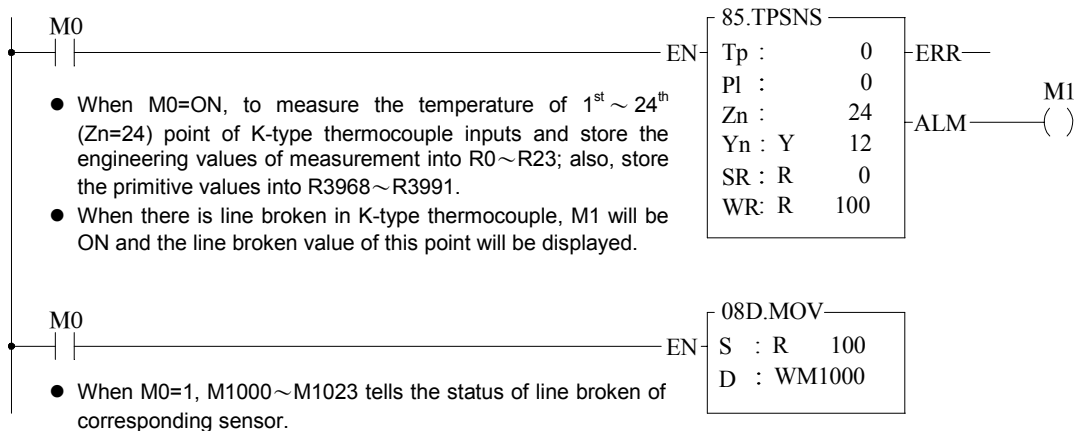

FUN 85 TPSNS	Convenient instruction proper to FB-4AJ(K)xx temperature module	FUN 85 TPSNS
-----------------	---	-----------------

Program example 2

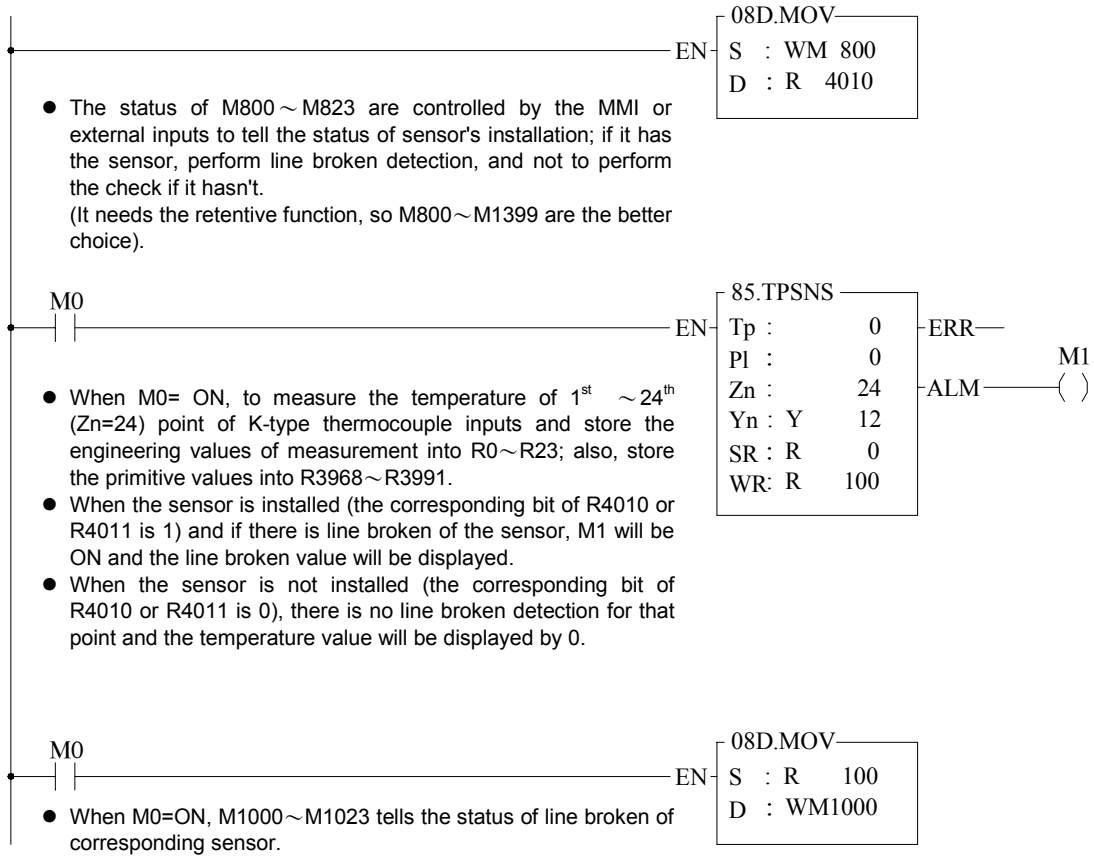

Temperature instruction proper to FB-4AJ(K)xx module

FUN 86 TPCTL	Convenient instruction of PID temperature control proper to FB-4AJ(K)xx module	FUN 86 TPCTL
-----------------	---	-----------------

Execution control—EN

Heating/Cooling—H/C

86.TPCTL

Yn :

Sn :

Zn :

Sv :

Os :

PR :

IR :

DR :

OR :

WR :

ERR—Parameter error

ALM—Warning indication

Yn: Starting address of PID ON/OFF output;
it takes Zn points.

Sn: Starting point of PID control of this instruction;
Sn = 0~23.

Zn: Number of the PID control of this instruction;
1≤Zn≤24 and 1≤Sn+Zn≤24

Sv: Starting register of the setpoint;
it takes Zn registers.

Os: Starting register of the in-zone offset;
it takes Zn registers.

PR: Starting register of the gain (Kc);
it takes Zn registers.

IR: Starting register of integral tuning constant
(Ti);it takes Zn registers..

DR: Starting register of derivative tuning constant
(Td); it takes Zn registers.

OR: Starting register of the PID analog output;
it takes Zn registers.

WR: Starting of working register for this
instruction.
It takes 9 registers and can't be repeated in
using.

Range	Y	HR	ROR	DR	K
	Y0	R0	R5000	D0	
	Y255	R3839	R8071	D3071	
Oper- and	○				
Yn					
Sn					0~23
Zn					1~24
Sv		○	○*	○	
Os		○	○*	○	
PR		○	○*	○	
IR		○	○*	○	
DR		○	○*	○	
OR		○	○*	○	
WR		○	○*	○	

Note: FUN86 must incorporate with FUN85 when using.

Function guide and notifications

- Fun85 instruction employs the multiplexing temperature module FB-4AJ(K)xx (where, xx may be 12,16,24) to get the current value of temperature and let it be as so called Process Variable (PV); after the calculation of software PID expression, it will respond the error with an output signal according to the setting of Set Point (SP),the error's integral and the rate of change of the process variable. Through the closed loop operation, the steady state of the process may be expected.
- Convert the output of PID calculation to be the time proportional on/off (PWM) output, and via transistor output to control the SSR for heating or cooling process; this is a good performance and very low cost solution.
- Through the analog output module (D/A module), the output of PID calculation may control the SCR or proportional valve to get more precise process control.
- Digitized PID expression is as follows:

$$Mn = [Kc \times En] + \sum_0^n [Kc \times Ti \times Ts \times En] - [Kc \times Td \times (PVn - PVn-1) / Ts]$$

Where,

Mn: Output at time “n”.

Kc: Gain (Range: 1~999 ; Pb=100(%) / Kc)

Ti: Integral tuning constant (Range:0~999, equivalent to 0.00~9.99 Repeat/Minute)

Td: Derivative tuning constant (Range:0~999, equivalent to 0.00~9.99 Minute)

PVn: Process variable at time “n”

PV n-1: Process variable when loop was last sovled

En: Error at time “n” ; E= SP – PVn

Ts: Solution interval for PID calculation (Valid value are 10, 20, 40, 80 ;the unit is in 0.1Sec)

FUN 86 TPCTL	Convenient instruction of PID temperature control proper to FB-4AJ(K)xx module	FUN 86 TPCTL
<div data-bbox="177 344 655 383" style="border: 1px solid black; padding: 2px;">Principle of PID parameter adjustment</div> <ul style="list-style-type: none"> ● As the gain (Kc) adjustment getting larger, the larger the proportional contribution to the output. This can obtain a sensitive and rapid control reaction. However, when the gain is too large, it may cause oscillation. Do the best to adjust “Kc” larger (but not to the extent of making oscillation), which could increase the process reaction and reduce the steady state error. ● Integral item may be used to eliminate the steady state error. The larger the number (Ti, integral tuning constant), the larger the integral contribution to the output. When there is steady state error, adjust the “Ti” larger to decrease the error. When the “Ti” = 0, the integral item makes no contribution to the output. For exa. , if the reset time is 6 minutes, $Ti=100/6=17$; if the integral time is 5 minutes, $Ti=100/5=20$. ● Derivative item may be used to make the process smoother and not too over shoot. The larger the number (Td, derivative tuning constant), the larger the derivative contribution to the output. When there is too over shoot, adjust the “Td” larger to decrease the amount of over shoot. When the “Td” = 0, the derivative item makes no contribution to the output. For exa, if the rate time is 1 minute, then the $Td = 100$; if the differential time is 2 minute, then the $Td = 200$. ● Properly adjust the PID parameters can obtain an excellent result for temperature control. ● The default of gain value (Kc) is as follows: When the setting of span and polarity of the module is 0~10V, the default of gain (Kc) is 60. When the setting of span and polarity of the module is 0~5V, the default of gain (Kc) is 30. When the setting of span and polarity of the module is -10~10V, the default of gain (Kc) is 120. When the setting of span and polarity of the module is -5~5V, the default of gain (Kc) is 60. ● The default of integral tuning constant is 17, it means the reset time is 6 minutes ($Ti=100/6=17$). ● The default of derivative tuning constant is 100, it means the rate time is 1 minutes ($Td=100$). <div data-bbox="188 1256 411 1294" style="border: 1px solid black; padding: 2px;">Instruction guide</div> <ul style="list-style-type: none"> ● FUN86 instruction must be incorporated with FUN85 ; the FUN85 instruction is for temperature measurement and it must be enabled, then, can the FUN86 start working. ● When execution control “EN” = 1, it depends on the input status of H/C for PID operation to make heating (H/C=1) or cooling (H/C=0) control. The current values of measured temperature are through the multiplexing temperature module FB-4AJ(K)xx to get ; the set points of desired temperature are stored in the registers starting from Sv. With the calculation of software PID expression, it will respond the error with an output signal according to the setting of set point, the error's integral and the rate of change of the process variable. Convert the output of PID calculation to be the time proportional on/off (PWM) output, and via transistor output to control the SSR for heating or cooling process; where there is a good performance and very low cost solution. It may also apply the output of PID calculation (stored in registers starting from OR), by way of D/A analog output module, to control SCR or proportional valve, so as to get more precise process control. ● When the setting of Sn, Zn ($0 \leq Sn \leq 23$ and $1 \leq Zn \leq 24$, as well as $1 \leq Sn + Zn \leq 24$) comes error, this instruction will not be executed and the instruction output “ERR” will be ON. ● This instruction compares the current value with the set point to check whether the current temperature falls within deviation range (stored in register starting from Os). If it falls in the deviation range, it will set the in-zone bit of that point to be ON; if not, clear the in-zone bit of that point to be OFF, and make instruction output “ALM” to be ON. 		

Temperature instruction proper to FB-4AJ(K)xx module

FUN 86 TPCTL	Convenient instruction of PID temperature control proper to FB-4AJ(K)xx module	FUN 86 TPCTL
<ul style="list-style-type: none"> ● In the mean time, this instruction will also check whether highest temperature warning (the register for the set point of highest temperature warning is R4008). When successively scanning for ten times the current values of measured temperature are all higher than or equal to the highest warning set point, the warning bit will set to be ON and instruction output “ALM” will be on. This can avoid the safety problem aroused from temperature out of control, in case the SSR or heating circuit becomes short. ● This instruction can also detect the unable to heat problem resulting from the SSR or heating circuit runs open, or the obsolete heating band. When output of temperature control turns to be large power (set in R4006 register) successively in a certain time (set in R4007 register), and can not make current temperature fall in desired range, the warning bit will set to be ON and instruction output “ALM” will be ON. ● WR: Starting of working register for this instruction. It takes 9 registers and can't be repeated in using. <ul style="list-style-type: none"> The content of the two registers WR+0 and WR+1 indicating that whether the current temperature falls within the deviation range (stored in registers starting from Os). If it falls in the deviation range, the in-zone bit of that point will be set ON; if not, the in-zone bit of that point will be cleared OFF. Bit definition of WR+0 explained as follows: <ul style="list-style-type: none"> Bit0=1, it represents that the temperature of the Sn+0 point is in-zone... Bit15=1, it represents that the temperature of the Sn+15 point is in-zone. Bit definition of WR+1 explained as follows: <ul style="list-style-type: none"> Bit0=1, it represents that the temperature of the Sn+16 point is in-zone... Bit7=1, it represents that the temperature of 24th point is in-zone. The content of the two registers WR+2 and WR+3 are the warning bit registers, they indicate that whether there exists the highest temperature warning or heating circuit opened. Bit definition of WR+2 explained as follows: <ul style="list-style-type: none"> Bit0=1, it means that there exists the highest warning or heating circuit opened at the Sn+0 point... Bit15=1, it means that there exists the highest warning or heating circuit opened at the Sn+15 point. Bit definition of WR+11 explained as follows: <ul style="list-style-type: none"> Bit0=1, it means that there exists the highest warning or heating circuit opened at the Sn+16 point... Bit7=1, it means that there exists the highest warning or heating circuit opened at the 24th point. Registers of WR+4 ~ WR+8 are used by this instruction. ● This instruction can only be used to perform heating or cooling control of positive temperature. ● Whether the FUN86 is placed in main or sub program and no matter the execution control “EN”=0 or 1, this instruction must be executed every scan. 		
<div style="border: 1px solid black; padding: 2px; display: inline-block;">Specific registers related to FUN86</div>		
<ul style="list-style-type: none"> ● R4005 : The content of Low Byte to define the solution interval between PID calculation <ul style="list-style-type: none"> =0, perform the PID calculation every 2 seconds (System default). =1, perform the PID calculation every 4 seconds. =2, perform the PID calculation every 8 seconds. ≥3, perform the PID calculation every 1 second. (R4004 must be 166 to make sense) : The content of High Byte to define the cycle time of PID ON/OFF (PWM) output. <ul style="list-style-type: none"> =0 · PWM cycle time is 2 seconds (system default) =1 · PWM cycle time is 4 seconds. =2 · PWM cycle time is 8 seconds. ≥3 · PWM cycle time is 1 second. 		
<p>Note 1: When changing the value of R4005, the execution control “EN” of FUN86 must be set at 0. The next time when execution control “EN” =1, it will base on the latest set point to perform the PID calculation.</p>		
<p>Note 2: The smaller the cycle time of PWM, the more even can it perform the heating. However, the error caused by the PLC scan time will also become greater. For the best control, it can base on the scan time of PLC to adjust the solution interval of PID calculation and the PWM cycle time.</p>		

FUN 86 TPCTL	Convenient instruction of PID temperature control proper to FB-4AJ(K)xx module	FUN 86 TPCTL
<ul style="list-style-type: none"> ● R4006: The setting point of large power output detection for SSR or heating circuit opened, or heating band obsolete. The unit is in % and the setting range falls in 80~100(%); system default is 90(%). ● R4007: The setting time to detect the continuing duration of large power output while SSR or heating circuit opened, or heating band obsolete. The unit is in second and the setting range falls in 300~65535 (seconds); system default is 600 (seconds). ● R4008: The setting point of highest temperature warning for SSR, or heating circuit short detection. The unit is in degree and the setting range falls in 50~65535; system default is 350 (degrees). ● R4012: Each bit of R4012 to tell the need of PID temperature control. Bit0=1 means that 1st point needs PID temperature control. Bit1=1 means that 2nd point needs PID temperature control. · · Bit15=1 means that 16th point needs PID temperature control. (The default of R4012 is FFFFH) ● R4013: Each bit of R4013 to tell the need of PID temperature control. Bit0=1 means that 17th point needs PID temperature control. Bit1=1 means that 18th point needs PID temperature control. · · Bit7=1 means that 24th point needs PID temperature control. (The default of R4013 is FFFFH) ● While execution control “EN”=1 and the corresponding bit of PID control of that point is ON (corresponding bit of R4012 or R4013 must be 1), the FUN73 instruction will perform the PID operation and respond to the calculation with the output signal. ● While execution control “EN”=1 and the corresponding bit of PID control of that point is OFF (corresponding bit of R4012 or R4013 must be 0), the FUN73 will not perform the PID operation and the output of that point will be OFF. ● The ladder program may control the corresponding bit of R4012 and R4013 to tell the FUN73 to perform or not to perform the PID control, and it needs only one FUN86 instruction. 		

Temperature instruction proper to FB-4AJ(K)xx module

FUN 86 TPCTL	Convenient instruction of PID temperature control proper to FB-4AJ(K)xx module	FUN 86 TPCTL
-----------------	---	-----------------

Program example

In following examples, the main unit is FBx-28MC(A), and the FB-4AK24 temperature module is attached ; the setting of the input span and polarity is 0~10V.

Program example 1

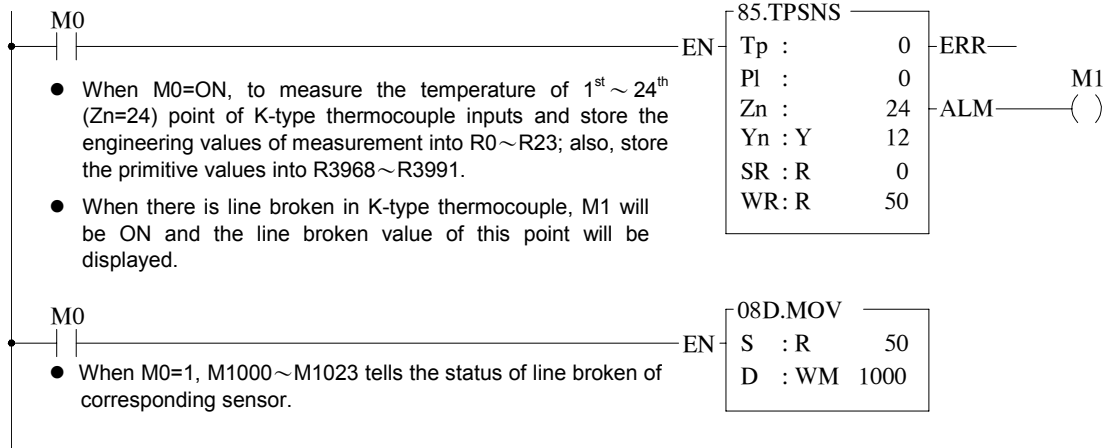

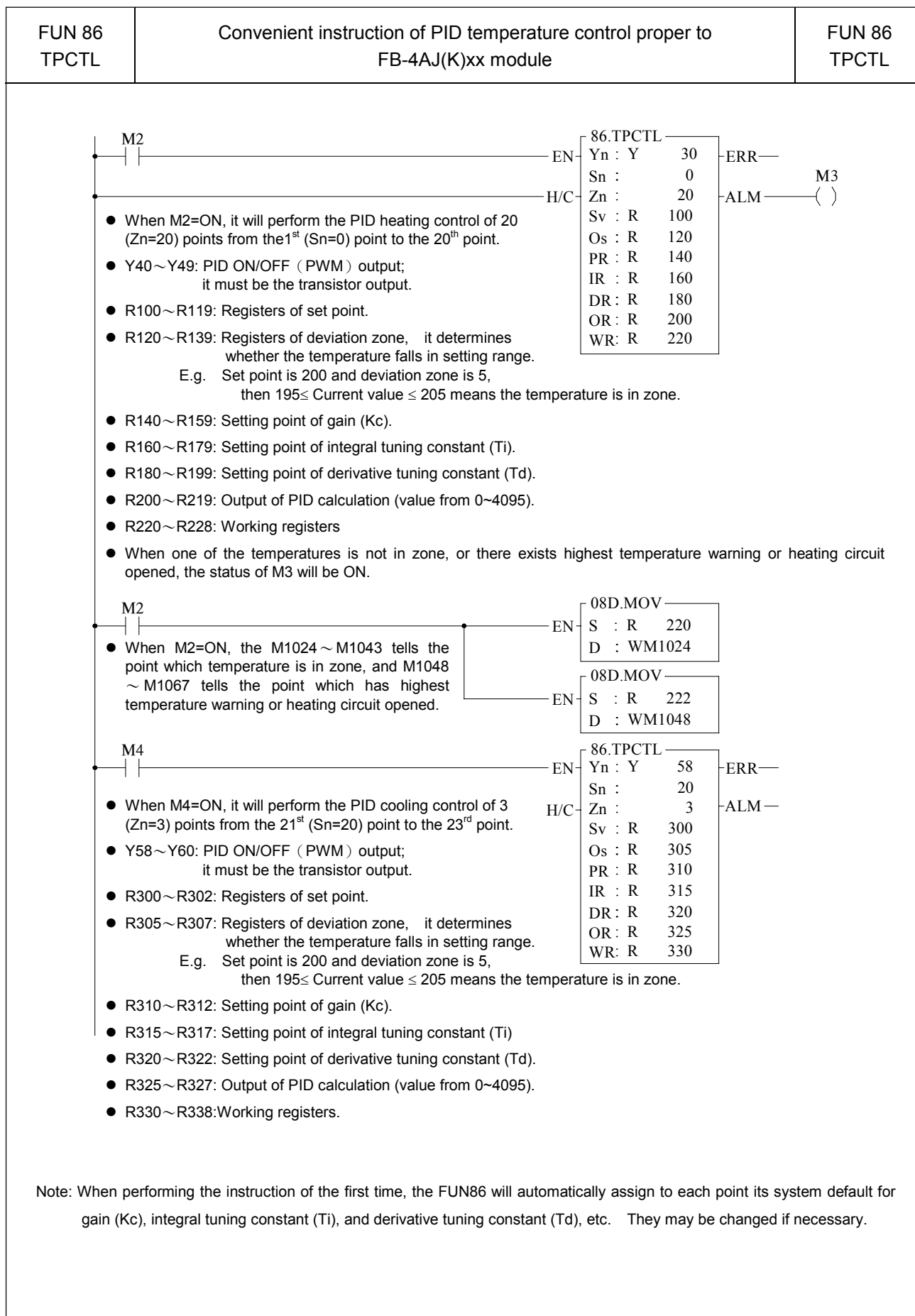

Temperature instruction proper to FB-4AJ(K)xx module

FUN 86 TPCTL	Convenient instruction of PID temperature control proper to FB-4AJ(K)xx module	FUN 86 TPCTL
-----------------	---	-----------------

Program example 2

